

2025
2027



Makine Ürün Machine Products

KATALOĞU CATALOGUE



“Dökümhanelerdeki Global Çözüm Ortağınız”



TÜM DÖKÜMHANE DÖVME YARDIMCI MALZEMELERİ DÖKÜM MAKİNELERİ OTOMASYON ÜRÜNLER YEDEK PARÇALAR

Yüksek Basıncılı Döküm ve Yardımcı Malzemeleri



Alçak Basıncılı Döküm ve Yardımcı Malzemeleri



Kokil Döküm ve Yardımcı Malzemeleri



Ekstrüzyon



Hassas Döküm ve Yardımcı Malzemeleri



Kum Döküm ve Yardımcı Malzemeleri



Dövme ve Yardımcı Malzemeleri

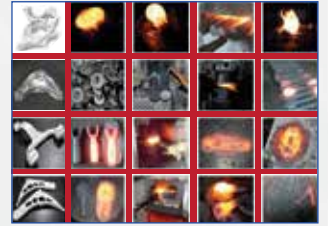

İngot - Sürekli - Bilet - Primer Alüminyum Döküm Ekipman ve Yardımcı Malzemeleri



Fabrika Merkez (Factory)

Tepeören İTOSB Mah. 9. Cad. No:6 34959 Tuzla / İstanbul
Tel: +90 444 28 81 Fax: +90 216 504 60 94

Avrupa Ofis ve Depo (Branch)

Rami Kışla Cad. Topçular İş Merkezi No: 236/248 34055 Eyüp / İstanbul
Tel: +90 212 565 71 18 Fax: +90 212 567 13 37

[/dogusdokum](https://www.dogusdokum.com) | www.dogusmetal.com



ÇÖZÜM ORTAKLARIMIZ

SOLUTION PARTNERS



DOGUS MACHINE

MAMMUT-WETRO
Schmelztiegelwerk GmbH



tribo-chemie
Trennen wie geschmiert

BALOSSI s.r.l.



DM

DOGUS CHEMICALS

DM

DOGUS COATINGS

HIGH TEMPERATURE SYSTEMS



DM

DOGUS MACHINE

ACESANA



DM

DOGUS CERAMIC

3M



DM

DOGUS LUBRICANTS

insertec

Furnaces & Refractories



F FERRO
T TERM
GmbH

DM

DOGUS METAL



www.dogusmetal.com | info@dogusmetal.com

DM **DOĞUŞ**
DÖKÜM MALZEMELERİ A.Ş.

DM **DOĞUŞ** MACHINE



Fabrika Merkez (Factory)

Tepeören İTOSB Mah. 9. Cad. No:6 34959 Tuzla / İstanbul

Tel: +90 444 28 81 Fax: +90 216 504 60 94

Avrupa Ofis Şube ve Depo (Branch)

Ramî Kışla Cad. Topçular İş Merkezi No: 236/248 34055 Eyüp / İstanbul

Tel: +90 212 565 71 18 Fax: +90 212 567 13 37

[f](https://www.facebook.com/dogusdokum) [in](https://www.linkedin.com/company/dogusdokum) [@](https://www.instagram.com/dogusdokum) [▶](https://www.youtube.com/channel/UC...) /dogusdokum



DM DOĞUŞ
DÖKÜM MALZEMELERİ A.Ş.



9001:2015



"Siz Hayal Edin, Biz Gerçekleştirelim"
"Just Imagine, We Make It Happen"

DM DOĞUŞ MACHINE



TÜBİTAK



KOSGEB



DOĞUŞ MAKİNE ÜRÜN GELİŞTİRME STRATEJİSİ



DOGUS MACHINE

DOGUS MACHINE PRODUCT DEVELOPMENT STRATEGY



Doğuş Makine ; Döküm sektöründeki 20 yılı aşkın tecrübenin birikimi ile Müşterilerden gelen yoğun talep üzerinde sektörün ihtiyacı olan birçok teknolojik makineyi üretmekte ve Dökümhanelere yeni otomasyon çözümleri sunmaktadır

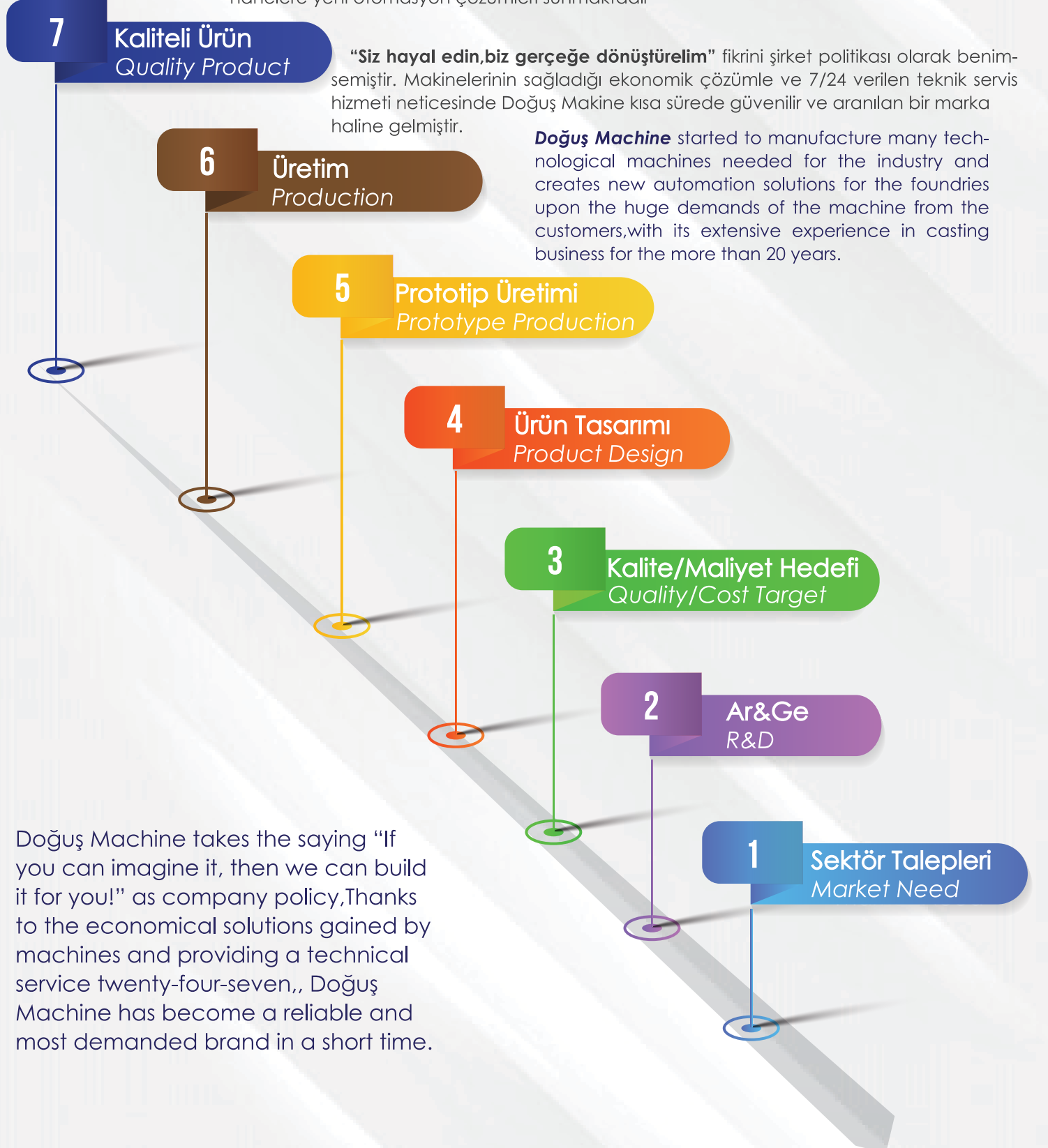



Flakslar



Sylon Kılıf



SiC Dalgakıranlar



Dökme Demir Silisyum Karbür



SiC Grafit Rotor Şaft



ADVANTAGES

- Reduction in Aluminium losses
- Less wastes; clear environment
- Mechanical and physical improvement
 - Energy and labor saving
 - Shortening of treatment time
 - Acceptable porosity
 - Savings of treatment materials
 - Homogenous microstructure

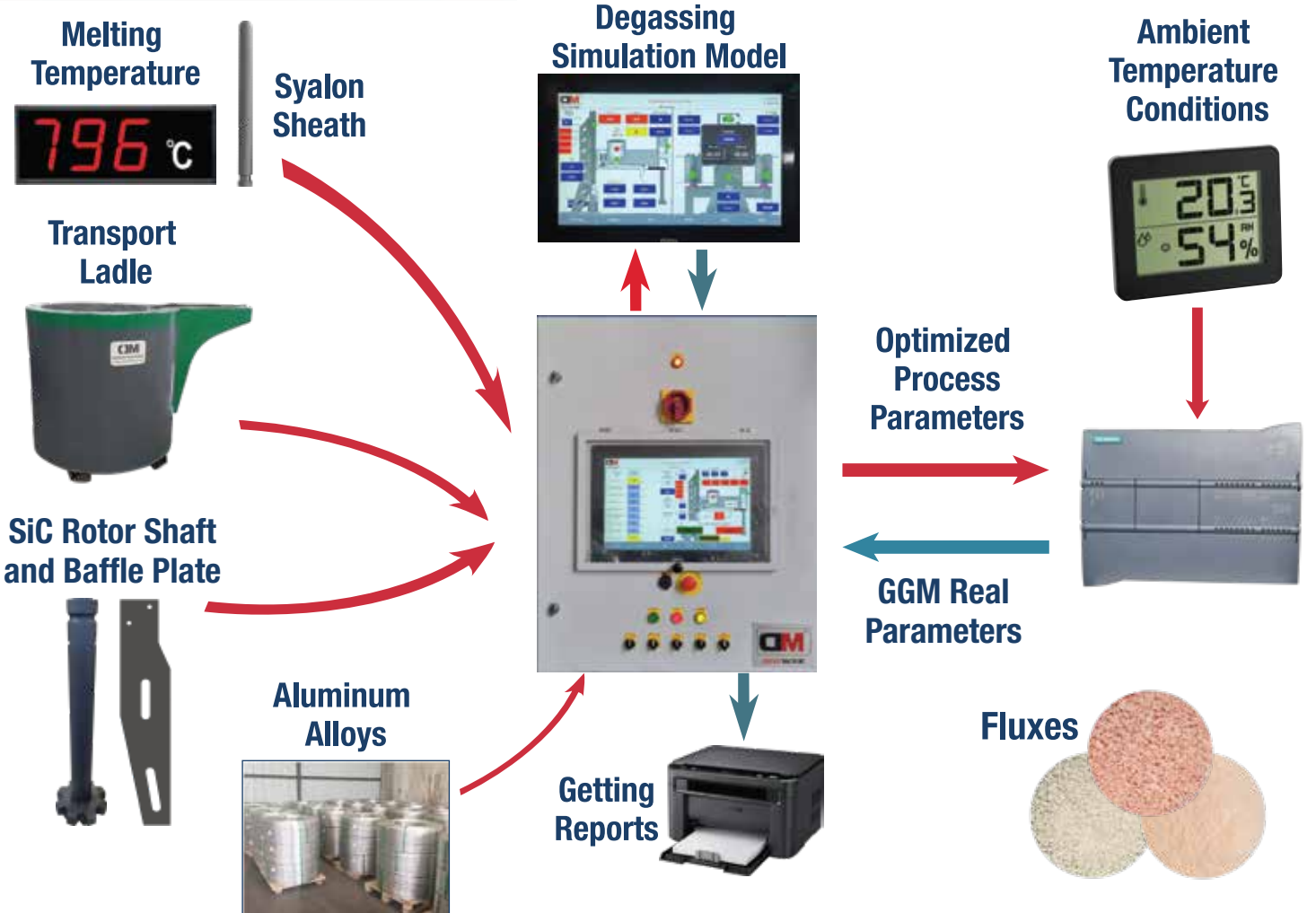

TEKNİK ÖZELLİKLER
TECHNICAL FEATURES

- Dokunmatik Kontrol Panel (**SIEMENS SIMATIC PANEL TOUCH**)
- Tüm UNIVERSAL ISO rotor-şaftların kullanımı Ø 75/150 mm L: 600-1200 mm
- Döner Platform, 3 ayrı yönde gaz alma pozisyonu (opsiyonel)
- Aynı anda Metal sıcaklığı kontrolü (°C), Azot gazı debi kontrolü(Lt/Dk.), Rotor devirlerinin kontrolü(rpm), Treatment Zamanının Kontrolü ve Data çıktıları (opsiyonel)
- 600' den 1200 uygulamaya kadar rotorların kullanım ömrü
- Rotor dizaynına uygun olarak 0'dan 840 rpm Rotor devir kapasitesi.
- Full Otomatik PLC Kontrol (**SIEMENS SIMATIC S7 300 PLC**)
- İstenilen miktar ve zamanda otomatik olarak granül flux ilavesi.
- İstenilen kaliteye uygun olarak 0 dakikadan 30 dakikaya kadar uygulama süresi.
- 200 kg'dan 1200 kg alaşıma kadar uygulama kapasitesi.
- Treatment esnasında metal sıcaklığı kontrolü (opsiyonel)
- Rotor dizaynına uygun olarak 2 lt'den 50 litre/dakikaya kadar Azot/ Argon çıkışı.
- Vorteks oluşumu ve gaz almanın yapılabilmesi için 2 zamanlı çalışan Dalga kıran
- Aynı anda iki farklı granül flux ilavesi (opsiyonel)
- Tepe lambasında sesli ve görsel uyarı sistemi
- Sürücüler (**SIEMENS MICROMASTER 440**)
- Akülü araba **Linde** yada **JUNGHEINRICH**
- Farklı alaşımlar için 50 ayrı alt program.
- Programlanabilir iki ayrı rotor devri
- 1 yıl parça ve servis garantili
- Diğer opsiyonlar için firmamızla irtibata geçebilirsiniz

- Touch Control Panel (**SIEMENS SIMATIC PANEL TOUCH**)
- Use of all the Universal-HSO rotors and shafts.Ø 75/150 mm L : 600~1200 mm
- Degassing rotation in 3 different direction (optional)
- At the same time, metal temperature control (°C), Nitrogen gas flow rate control (l/m), control of rotor speed (rpm), control of treatment time and data output (optional)
- Lifetimes of the rotors are between 600 and 1200 applications.
- In accordance with rotor design, from 0 to 840 rpm rotation speed.
- Full Automatic PLC Control (**SIEMENS SIMATIC S7 300 PLC**)
- Automatic granular flux addition at desired quantity and time.
- In accordance with desired quality, application period is from 0 to 30 minutes.
- Application capacity from 200 kg to 1200 kg alloy.
- Metal temperature control during the treatment (optional).
- In accordance with the rotor design, Nitrogen outlet is from 2 to 50 liters per minute.
- Baffle plate working at two different speeds for formation of vortex and degassing.
- Two different granular fluxes at the same time (optional).
- Audio and visual warning system on control panel and beacon lamp.
- Drivers (**SIEMENS MICROMASTER 440**)
- Battery-powered car **Linde** or **JUNGHEINRICH**
- 50 different sub-program for different alloys
- Two separate programmable motor speed.
- 1 year guarantee of spare part and service.

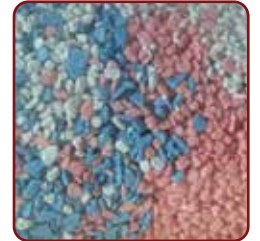

Ürün Adı Product Name	Özellik Properties	Uygulama Application
ALUFLUX ENVİRO DTS 20/26 G	Sodyum & Kalsiyum içermeyen Cüruf ve Oksit Giderici Flux Sodium & Calcium Free Slag and Oxide Remover Flux	Al-Mg, Al-Si Alaşımlarında 700 - 780 °C aralığında Al-Mg, Al-Si Alloys with in 700 - 780 °C
ALUFLUX ENVİRO DTS 10 G	Sodyum & Kalsiyum içermeyen Kalsiyum Giderici Flux Sodium & Calcium Free Calcium Remover Flux	Al-Mg, Al-Si Alaşımlarında 700 - 780 °C aralığında Al-Mg, Al-Si Alloys with in 680 - 740 °C
ALUFLUX ENVİRO DM CRM 1G	Sodyum & Kalsiyum içermeyen Cüruf ve Oksit Egzotermik Giderici Flux Sodium & Calcium Free Slag and Oxide Remover Flux	Al-Mg, Al-Si Alaşımlarında 700 - 780 °C aralığında Al-Mg, Al-Si Alloys with in 750 - 860 °C

AVANTAJLAR
ADVANTAGES

- Alüminyum kayıplarında azalma
- Daha az atık; daha temiz çevre
- Mekanik ve fiziksel iyileşme
- Enerji ve işçilikten tasarruf
- İşlem süresinin kısalması
- Kabul edilebilir porozite
- İşlem ürünleri tasarrufu
- Homojen mikroyapı

- Reduction in Aluminium losses
- Less wastes; clear environment
- Mechanical and physical improvement
- Energy and labor saving
- Shortening of treatment time
- Acceptable porosity
- Savings of treatment materials
- Homogenous microstructure



GAZ ALMA VE CÜRUF GİDERME MAKİNELERİ
DEGASSING AND SLAGGING OFF MACHINES

DTS 3437 GI-DM



GAZ ALMA VE CÜRUF GİDERME MAKİNELERİ

DEGASSING AND SLAGGING OFF MACHINES

• TEKNİK ÖZELLİKLER

- Dokunmatik: Kontrol Panel (**SIEMENS SIMATIC PANEL TOUCH**)
- Tam Otomatik: PLC Kontrol (**SIEMENS SIMATIC S71200 PLC**)
- Gaz alma makinesi ile birlikte senkronize haberleşme sistemi
- Rotor dizaynına uygun olarak 2 lt'den 50 litre/dakikaya kadar Azot/ Argon çıkışı
- Rotor dizaynına uygun olarak 2 lt'den 50 litre/dakikaya kadar Mix Gaz çıkışı
- Rotor dizaynına uygun olarak 2 lt'den 50 litre/dakikaya kadar 2. Mix Gaz çıkışı (Opsiyonel)
- Vorteks oluşumu ve gaz almanın yapılabilmesi için 2 zamanlı çalışan Dalgakıran
- Anlık sıvı metal ısı kontrolü ve düşük metal ısı uyarı sistemi
- Lt/dk cinsinden Gaz akış debi kontrolü ve düşük debi uyarı
- Şarj Numarasına göre; metal ısı, debi, uygulama zamanı verilerinin depolanması ve data çıkışı
- Tüm UNIVERSAL ISO rotor-Şaftların kullanımı Ø 75/150 mm L: 600-1200 mm
- İstenilen kaliteye uygun olarak 0 dakikadan 30 dakikaya kadar uygulama süresi
- Rotor dizaynına uygun olarak 0'dan 840 rpm Rotor devir kapasitesi
- İstenilen miktar ve zamanda otomatik olarak granül flaks ilavesi
- 300 kg'dan 1200 kg alışıma kadar uygulama kapasitesi
- Gaz yada Flaks yoksa otomatik start almama özelliği
- Tepe lambasında sesli ve görsel uyarı sistemi
- Gaz yada Flaks seviyesinde azalma uyarısı
- Farklı alışımlar için sınırsız alt program
- Programlanabilir iki ayrı rotor devri
- Sürücüler (**SIEMENS SINAMICS V20**)
- 1 yıl parça garantili
- Diğer opsiyonlar için firmamızla irtibata geçebilirsiniz

• TECHNICAL FEATURES

- Touch Control Panel (**SIEMENS SIMATIC PANEL TOUCH**)
- Full Automatic PLC Control (**SIEMENS SIMATIC S71200 PLC**)
- Synchronized communication system with degassing machine
- In accordance with the rotor design, Nitrogen/ Argon outlet is from 2 to 50 liters per minute
- In accordance with the rotor design, Mixed Gas outlet is from 2 to 50 liters per minute
- In accordance with the rotor design, 2. Mixed Gas outlet is from 2 to 50 liters per minute (Optional)
- Baffle plate working at two different speeds for formation of vortex and degassing
- Instant temperature control of molten metal and low metal temperature warning system
- Data saving of metal temperature, flow, treatment time as per the charge number and data output
- Use of all the Universal-ISO rotors and shafts Ø 75/150 mm L: 600-1200 mm
- In accordance with desired quality, application period is from 0 to 30 minutes
- In accordance with rotor design, from 0 to 840 rpm rotation speed
- Automatic granular flux addition at desired quantity and period of time
- Application capacity from 300 kg to 1200 kg alloy
- No automatic start if there is no gas or flux
- Audio and visual warning system on beacon lamp
- Gas flow control as lt/mn. and low flow warning
- Alarm in case of not enough gas or flux
- Unlimited sub programs for different alloys
- Two separate programmable rotor speed
- Drivers (**SIEMENS SINAMICS V20**)
- 1 year-guarantee of parts
- You can contact our company for other options.



• AVANTAJLAR

- Alüminyum kayıplarında azalma
- Daha az atık daha temiz çevre
- Mekanik ve fiziksel iyileşme
- Enerji ve işçilikten tasarruf
- İşlem süresinin kısalması
- Kabul edilebilir porozite
- İşlem ürünleri tasarrufu
- Homojen mikroyapı

• ADVANTAGES

- Reduction in Aluminium losses
- Less wastes; clear environment
- Mechanical and physical improvement
- Savings of treatment materials
- Shortening of treatment time
- Acceptable porosity
- Energy and labor saving
- Homogenous microstructure

GAZ ALMA VE CÜRUF GİDERME MAKİNELERİ

DEGASSING AND SLAGGING OFF MACHINES



DTS 3437 GI-DM



DTS 3437 GI-FF

Tam Otomatik Gaz Alma ve Cüruf Giderme + Alaşım Besleme Sistemi

Tam Otomatik Flaks Beslemesiz Gaz Alma ve Cüruf Giderme Makinası



DTS 3437 GI-PD



DTS 3437 GI-TD

Tam Otomatik Portatif Gaz Alma ve Cüruf Giderme Makinesi

Tam Otomatik Transpaletli Gaz Alma ve Cüruf Gidere Makinası



DTS 3437 GI-LD



DTS 3437 GDA DC

Tam Otomatik Laboratuar Tipi Gaz Alma ve Cüruf Giderme Makinesi

Tam Otomatik Portatif Gaz Alma ve Cüruf Giderme Makinesi

GAZ ALMA VE CÜRUF GİDERME MAKİNELERİ

DEGASSING AND SLAGGING OFF MACHINES

TEKNİK ÖZELLİKLER

- Full Otomatik PLC Kontrol (SIEMENS SIMATIC S7 1200 PLC)
- Dokunmatik Kontrol Panel (SIEMENS SIMATIC PANEL TOUCH)
- Sürücüler (SIEMENS SINAMICS V20)
- Farklı alaşımlar için 10 ayrı alt program
- Rotor dizaynına uygun olarak 0'dan 840 rpm Rotor devir kapasitesi
- Programlanabilir iki ayrı rotor devri
- 200 kg'den 1200 kg alaşıma kadar uygulama kapasitesi
- İstenilen miktar ve zamanda otomatik olarak granül flux ilavesi
- Aynı anda iki farklı granül flux ilavesi (opsiyonel)
- İstenilen kaliteye uygun olarak 0 dakikadan 30 dakikaya kadar uygulama süresi
- Rotor dizaynına uygun olarak 2 lt'den 50 litre/dakikaya kadar Azot/Argon çıkışı
- Treatment esnasında metal sıcaklığı kontrolü (opsiyonel)
- Aynı anda Metal sıcaklığı kontrolü (°C), Azot gazı debi kontrolü (Lt/Dk.), Rotor devirlerinin kontrolü (rpm), Treatment Zamanının Kontrolü ve Data çıkışları (opsiyonel)
- Vorteks oluşumu ve gaz almanın yapılabilmesi için 2 zamanlı çalışan Dalga kırın
- Tepe lambasında sesli ve görsel uyarı sistemi
- Tüm UNIVERSAL ISO rotor-shaftların kullanımı Ø 75/150 mm L : 600~1200 mm
- 600'den 1200 uygulamaya kadar rotorların kullanım ömrü
- 1 yıl parça ve servis garantili

TECHNICAL FEATURES

- Full Automatic PLC Control (SIEMENS SIMATIC S7 1200 PLC)
- Touch Control Panel (SIEMENS SIMATIC PANEL TOUCH)
- Drivers (SIEMENS SINAMICS V20)
- 10 different sub-program for different alloys
- In accordance with rotor design, from 0 to 840 rpm rotation speed
- Two separate programmable motor speed
- Application capacity from 200 kg to 1200 kg alloy
- Automatic granular flux addition at desired quantity and time
- Two different granular fluxes at the same time (optional)
- In accordance with desired quality, application period is from 0 to 30 minutes.
- In accordance with the rotor design, Nitrogen outlet is from 2 to 50 liters per minute.
- Metal temperature control during the treatment (optional)
- At the same time, metal temperature control (°C), Nitrogen gas flow rate control (l/m), control of rotor speed (rpm), control of treatment time and data output (optional)
- Baffle plate working at two different speeds for formation of vortex and degassing.
- Audio and visual warning system on control panel and beacon lamp.
- Use of all the Universal-ISO rotors and shafts. Ø 75/150 mm L : 600~1200 mm
- Lifetimes of the rotors are between 600 and 1200 applications
- 1 year guarantee of spare part and service.

Machined Graphite Rotor



* Rotor Hızı 350 rpm
* Gaz akışı 25 Lt/DK.

Silicon Carbide Rotor



* Rotor speed 350 rpm
* Gas Flow 25 litres per minute

- Ø 150/75 mm, L : 700 ~ 1200 mm
- Ø 200/75 mm, L : 700 ~ 1200 mm

Baffle Plate

Cast Iron



SiC

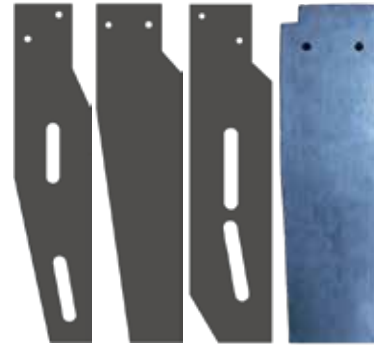

SiC Graphite Rotor Shafts



AVANTAJLAR

- Mekanik ve fiziksel iyileşme
- Kabul edilebilir porozite
- Homojen mikroyapı
- Alüminyum kayıplarında azalma
- İşlem ürünleri tasarrufu
- İşlem süresinin kısalması
- Enerji ve işçilikten tasarruf
- Daha az atık daha temiz çevre

ADVANTAGES

- Mechanical and physical improvement
- Acceptable porosity
- Homogenous microstructure
- Reduction in Aluminium losses
- Savings of treatment materials
- Shortening of treatment time
- Energy and labor saving
- Less wastes; clear environment



BAKIR ALAŞIMLARI İÇİN GAZ ALMA VE CÜRUF GİDERME MAKİNELERİ
DEGASSING AND SLAGGING OFF SYSTEM COPPER ALLOYS



AVANTAJLAR

- Bakır kayıplarında azalma
- Daha az atık daha temiz çevre
- Mekanik ve fiziksel iyileşme
- Enerji ve işçilikten tasarruf
- İşlem süresinin kısalması
- Kabul edilebilir porozite
- İşlem ürünleri tasarrufu
- Homojen mikroyapı

ADVANTAGES

- Reduction in Copperlosses
- Less wastes; clear environment
- Mechanical and physical improvement
- Savings of treatment materials
- Shortening of treatment time
 - Acceptable porosity
 - Energy and labor saving
- Homogenous microstructure

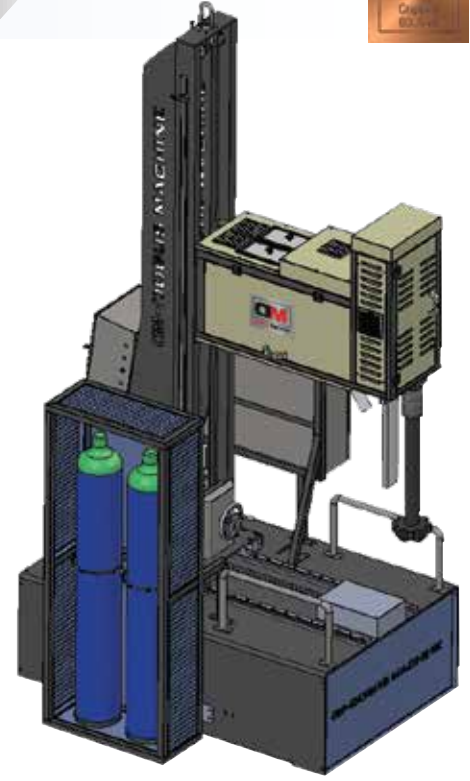

DM GENIUS DEGASSING, SLAG REMOVAL AND VACUUM DENSITY COMMUNICATION MACHINE

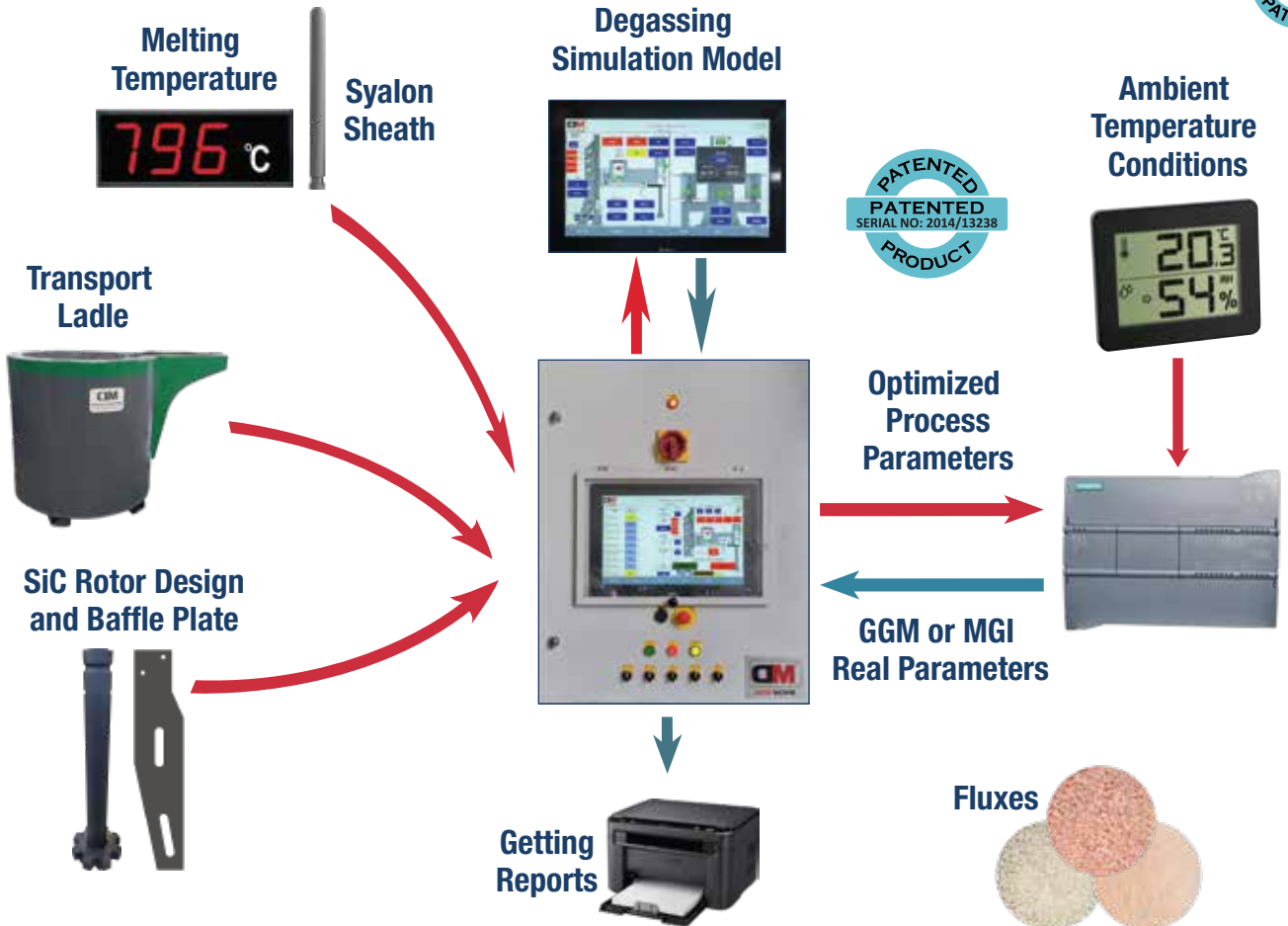

TAM OTOMATİK ALAŞIM BESLEME MAKİNELERİ FULL AUTOMATIC ALLOY FEEDING MACHINES

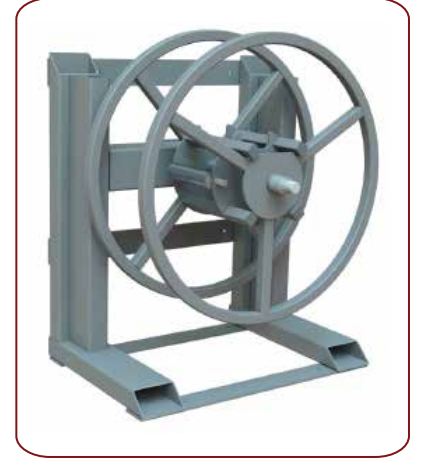
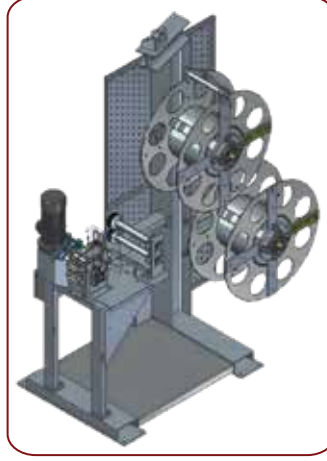

TEKNİK ÖZELLİKLER

- Süre ayarlı ekran üzerinden kontrollü master alaşım miktarı belirleme ve cm/mm ölçüsüne göre belirlenen miktarlarda alaşım elementi besleme
- 300 mm yukarı-aşağı hareket, motor-redüktör invertör kontrollü, limit switchi
- Gaz giderme makinası ile entegre çalışma ve gaz giderme cihazı üzerinden kontrol
- Master alaşımı doğrudan eriyik alüminyuma enjekte etme
- Eş zamanlı yada ayrı ayrı AlTiB-AISr alaşım besleme
- Sürücüler (SIEMENS SINAMICS G120/G120C Serisi)
- Master alaşım algılama sensörü
- Tam otomatik PLC Kontrol
- Bağımsız çalışma özelliği

TECHNICAL FEATURES

- Controlled master alloy amount determination on control screen and feeding the alloy element in the amount determined according to the cm/mm measure
- 300 mm up and down movement stroke
- Integrated operation with degassing machine and control via degassing machine
- Feeding the master alloy directly into the molten aluminum
- Simultaneous or separate AlTiB-AISr alloy feeding
- Drivers (Siemens Sinamic G120/G120C Series)
- Master alloy detection sensor
- Full automatic PLC control
- Independent working feature

ALÜMİNYUM SÜREKLİ DÖKÜM İÇİN GAZ ALMA MAKİNELERİ

DEGASSING MACHINES FOR ALUMINIUM CONTINOUS CASTING

DTS 343767 - 2022



TEKNİK ÖZELLİKLER

- Rotor dizaynına uygun olarak 2 lt'den 50 litre/dakikaya kadar Azot/Argon çıkışı
- Vorteks oluşumu ve gaz almanın yapılabilmesi için 2 zamanlı çalışan Dalga kırarı
- Dokunmatik Kontrol Panel (**SIEMENS SIMATIC PANEL TOUCH**)
- Aynı anda Metal sıcaklığı kontrolü (°C), Azot gazı debi kontrolü (Lt/Dk.), Rotor devirlerinin kontrolü (rpm), Treatment Zamanının Kontrolü ve Data çıkışları (opsiyonel)
- İstenilen kaliteye uygun olarak 0 dakikadan 240 dakikaya kadar uygulama süresi
- Tüm UNIVERSAL ISO rotor-shaftların kullanımı. Ø 75/150 mm L : 600~1200 mm
- Rotor dizaynına uygun olarak 0'dan 840 rpm Rotor devir kapasitesi
- Full Otomatik PLC Kontrol (**SIEMENS SIMATIC S7 1200 PLC**)
- 600'den 1200 uygulamaya kadar rotorların kullanım ömrü
- İşlem esnasında metal sıcaklığı kontrolü (opsiyonel)
- Metal sıcaklığı kontrolü Data çıkışı (opsiyonel)
- Tepe lambasında sesli ve görsel uyarı sistemi
- Farklı alaşımlar için 5 ayrı alt program
- Programlanabilir iki ayrı rotor devri
- Sürücüler (**SIEMENS SINAMICS V20**)
- 1 yıl parça ve servis garantili

TECHNICAL FEATURES

- In accordance with the rotor design, Nitrogen outlet is from 2 to 50 liters per minute
- Baffle plate working at two different speeds for formation of vortex and degassing.
- Touch Control Panel (**SIEMENS SIMATIC PANEL TOUCH**)
- At the same time, metal temperature control (°C), Nitrogen gas flow rate control (l/m), control of rotor speed (rpm), control of treatment time and data output (optional)
- In accordance with desired quality, application period is from 0 to 240 minutes
- Use of all the Universal-ISO rotors and shafts. Ø 75/150 mm L : 600~1200 mm
- In accordance with rotor design, from 0 to 840 rpm rotation speed
- Full Automatic PLC Control (**SIEMENS SIMATIC S7 1200 PLC**)
- Lifetimes of the rotors are between 600 and 1200 applications.
- Metal temperature control during the treatment (optional)
- Data output of metal temperature control (optional)
- Audio and visual warning system on control panel and beacon lamp.
- 5 different sub-program for different alloys
- Two separate programmable motor speed
- Drivers (**SIEMENS SINAMICS V20**)
- 1 year guarantee of spare part and service.



TEK TANKLI FLAKS BESLEME CİHAZI FLUX FEEDER WITH ONE TANK



• TEKNİK ÖZELLİKLER

- Dokunmatik Kontrol Panel (SIEMENS SIMATIC PANEL TOUCH) sayesinde tüm ayarlar kolayca yapılabilir
- Full Otomatik PLC Kontrol (SIEMENS SIMATIC PLC)
- Tüm işlemler tek bir tuşla otomatik olarak başlar ve işlem bittikten sonra otomatik olarak son bulup sesli ve görsel olarak operatörü uyarır.
- Yüksek basınçlara dayanıklı paslanmaz tank (8 mm sac)
- 100 Kg. Flaks kapasitesi
- İstenilen miktarda (0,1 ~ 2 Kg/Dk) otomatik olarak flax enjektör kapasitesi.
- İstenilen miktarda (10 ~ 100 Lt/Dk) otomatik olarak gaz enjektör kapasitesi.
- İstenilen kaliteye uygun olarak 0 dakikadan 90 dakikaya kadar uygulama süresi.
- Flaks ya da gaz bittiği zaman otomatik stop ve uyar sistemleri.
- Kontrol Panel ve tepe lambasında sesli ve görsel uyar sistemi
- Granul yada Toz Tüm UNIVERSAL flakslar kullanılabilir.
- 1 yıl parça ve servis garantili

• TECHNICAL FEATURES

- All the setting can be made easily thanks to the Touch Control Panel (SIEMENS SIMATIC PANEL TOUCH)
- Full Automatic PLC Control (SIEMENS SIMATIC PLC)
- All the operations start only with one button and after the operation finishes, the unit automatically stops and gives an audio-visual warning for the operator.
- Stainless steel tank frame resistant to the high pressure (8 mm plate)
- 100 kg Flux capacity
- Automatic flux injection capacity at desired quantity (0,1 ~ 2 Kg/mn)
- Automatic gas injection capacity at desired quantity (10~ 100 Lt/mn)
- Application time from 0 to 90 minutes according to required quality
- Automatically stops when the flux or gas finishes.
- Audio and visual warning system on control panel and beacon lamp.
- All UNIVERSAL fluxes can be used granular or powder form.
- 1 year guarantee of spare parts and service.

• AVANTAJLAR

- Mekanik ve fiziksel iyileşme
- Kabul edilebilir porozite
- Homojen mikroyapı
- Alüminyum kayıplarında azalma
- İşlem ürünleri tasarrufu
- İşlem süresinin kısalması
- Enerji ve işçilikten tasarruf
- Daha az atık daha temiz çevre

• ADVANTAGES

- Mechanical and physical improvement
- Acceptable porosity
- Homogenous microstructure
- Reduction in Aluminium losses
- Savings of treatment materials
- Shortening of treatment time
- Energy and labor saving
- Less wastes; clear environment



Flaks Çeşitleri

ÇİFT TANKLI FLAKS BESLEME CİHAZI

FLUX FEEDER WITH TWO TANKS



• TEKNİK ÖZELLİKLER

- Dokunmatik Kontrol Panel (**SIEMENS SIMATIC PANEL TOUCH**) sayesinde tüm ayarlar kolayca yapılabilir
- Kontrol Panel ve tepe lambasında sesli ve görsel uyan sistemi
- İstenilen miktarda (0,1 - 2,5 Kg/Dk) otomatik olarak flax enjekte kapasitesi
- Tüm işlemler tek bir tuşla otomatik olarak boşlar ve işlem bittikten sonra otomatik olarak son bulup sesli ve görsel olarak operatörü uyarır
- Yüksek basınçlara dayanıklı paslanmaz tank (8 mm sac)
- İstenilen kaliteye uygun olarak 0 dakikadan 90 dakikaya kadar uygulama süresi.
- İstenilen miktarda (10 -100 Lt/Dk) otomatik olarak gaz enjekte kapasitesi
- Aynı anda Granül yada Toz Flak kullanma imkanı
- Flaks yada gaz bittiği zaman otomatik stop ve uyarı sistemleri
- Full Otomatik PLC Kontrol (SIEMENS SIMATIC PLC)
- 2x50 Kg Toplamda 100 Kg. Flaks kapasitesi
- Tüm UNİYERSAL flakslar kullanılabilir
- 1 yıl parça ve servis garantili

• TECHNICAL FEATURES

- All the setting can be made easily thanks to the Touch Control Panel (SIEMENS SIMATIC PANEL TOUCH)
- Full Automatic PLC Control (SIEMENS SIMATIC PLC)
- All the operations start only with one button and after the operation finishes, the unit automatically stops and gives an audio-visual warning for the operator
- Strong tank frame resistant to the high pressure (8 mm plate)
- 150kg Flux capacity
- Automatic flux injection capacity at desired quantity (0,1-2,5 Kg/mn)
- Automatic gas injection capacity at desired quantity (10-100 Lt/mn)
- Application time from 0 to 90 minutes according to required quantity
- Flux mixing motor in order to prevent the blockage.
- Automatically stops when the flux or gas finishes
- Audio and visual warning system on control panel and beacon lamp.
- All UNIVERSAL fluxes can be used.
- 1 year guarantee of spare part and service

• AVANTAJLAR

- Alüminyum kayıplarında azalma
- Daha az atık daha temiz çevre
- Mekanik ve fiziksel iyileşme
- Kabul edilebilir porozite
- Enerji ve işçilikten tasarruf
- İşlem süresinin kısalması
- İşlem ürünleri tasarrufu
- Homojen mikroyopı

• ADVANTAGES

- Mechanical and physical improvement
- Acceptable porosity
- Homogenous microstructure
- Reduction in Aluminium losses
- Savings of treatment materials
- Shortening of treatment time
- Energy and labor saving
- Less wastes; clear environment

FLAKS ATMA CİHAZI
FLUX SPRAY
•TEKNİK ÖZELLİKLER
•TECHNICAL FEATURES

1. Uygunluk : İnce tuz, taneler, paletler, granüller
2. Besleme Borusu : Pnömatik Venturi
3. Karıştırıcı Motor : Pnömatik
4. Çalışma Hava Basıncı : 4/6 bar (maksimum 8 bar)
5. Bağlantı Ölçüsü : Ø 3/4
6. Yağlayıcı : Metal work

1. Suitable For : Fine salt, flakes, pellets, granular
2. Delivery Tube : Pneumatic - Venturi
3. Stirrer Motor : Pneumatic
4. Working Air Press : 4/6 bar (max 8 bar)
5. Connection Size : Ø 3/4
6. Lubricator : Metal work

Yeni Model Flaks Spray Cihazı



Flaks Çeşitleri

•AVANTAJLAR
•ADVANTAGES

- İstenilen gramaj ayarlanabilir
- 50 kg - 1000 kg arası kapasite, siparişe göre imal edilebilir.
- Paslanmaz çelik gövde
- 25 kg hazne kapasitesi
- Kolay taşınabilir

- Desired weight can be adjustable
- 25 kg hopper capacity
- 50 kg - 1000 kg, it can be produce, according to order
- Stainless steel body
- Easy to carry

POTA ISITMA ÜNİTESİ LADLE HEATING UNIT



AVANTAJLAR

- 128 kg/m³ seramik yünü ve 300 kg/m³ seramik board ile izolasyonu yapılan hareketli kapak
- Kapak aşağı yukarı hareketini sağlayan buton kontrollü ve limit switchli asansör
- Ara yüzey izolasyonlu Pota emniyet ve koruma kovani
- Termokupl ile sıcaklık kontrolü
- Max. 400 °C pota içi sıcaklığı sağlama
- Elektrik Rezistans ile Isıtma
- 300-1200 kg arası potalara uygulama



Talebe Göre, Elektrikli ya da Gazlı Seçeneğiyle

• TEKNİK ÖZELLİKLER

- Sıcaklık kontrolü için termokupl ve ısı kontrol cihazı
- Ataçman türüne göre dizayn edilen hareketli kapak
- 300-1200 kg arası potalara uygulama
- 20 - 100kw ısıtma gücü (doğalgaz)
- Aşırı ısınma emniyeti
- Pota algılayıcı sensör

• TECHNICAL FEATURES

- Thermocouple and temperature control device for temperature control
- Movable cover designed according to attachment type
- Application between 300-1200 kg
- 20-100 kw heating power (natural gas)
- Overheating safety
- Detector sensor of crucible



TERAZİLİ VAKUM YOĞUNLUK TEST CİHAZI

WEIGHING VACUUM DENSITY TESTER



*2023 Yeni Model



• AVANTAJLAR

- İndeks hesabı için her kullanıcıya şifre tanımla ve işlem geçmişi görebilme
- Yoğunluk indeksinin hesaplanarak porozitenin hesaplanması
- Renkli, dokunmatik 5.7" TFT ekranlı ve membran tuş takımlı
- Gaz alma ve Cüruf alma işleminin doğruluğunun tespiti
- Poroziteden kaynaklanan döküm firelerinin bitmesi
- Döküm öncesi ergimiş metal kalitesinin ölçümü
- Programlanabilir infrared yaklaşım sensörleri
- Yüksek kalite döküm, büyük tasarruf
- Otomatik indeks hesaplama
- Sahada indeks belirleme
- Ayrılabilir ekran

• ADVANTAGES

- To define password for each user for the index account and to see the transaction history
- Color touch-sensitive 5.7 TFT screen and membrane keypad
- Calculation of the porosity by calculating the density index
- Determination of degassing and slagging off applications
- Measurement of melted metal before casting
- Programmable infrared proximity sensors
- End of casting wastes due to the porosity
- High quality castings, big savings
- Determining index on the field
- Automatic index calculation
- Detachable screen

K MOLD SIVI ALÜMİNYUM TEST EKİPMANI

K MOLD LIQUID ALUMINUM TESTING EQUIPMENT

K-mold, üretim koşullarında alüminyum eriyiğinin makro temizliğini değerlendirmekte kullanılır
K mold değeri $K = S/n$

K- Bir numunenin bir parçasının kırılma yüzeyinde bulunan inklüzyon sayısı
S- Küçük inceleme alanının n-adetinde bulunan toplam inklüzyon sayısı
n- İncelenen numune sayısı

Her döküm tesisinin K-mold değerlerine dayanarak her ürün için kendi ölçeğini / aralığını oluşturması gerekir
(düşük K-mold değeri daha temiz eriyik anlamına gelir)

The purpose of K mold is to evaluate the macro cleanliness of molten aluminum melt at production conditions.
K mold value: $K = S/n$

K - number of inclusions found in one piece of a sample within fracture surface
S - total number of inclusions found in n-pieces of the small probe
n - number of examined samples

Every casting plant need to establish its own scale/range for each product based on K-mold values
(lower K mold value means cleaner melt)

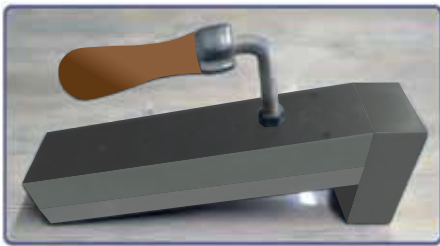

*2024 Yeni Model

• AVANTAJLAR

- Inklüzyonlara ve oksit filme karşı hassas olması
- Kolay numune alma ve eriyik temizliği değerlendirmesi;
- Maliyetinin düşük olması
- Hızlı değerlendirme
- Yüksek doğruluk
- Kolay kullanım
- Taşınabilir

• ADVANTAGES

- Quick evaluation (approximately 10 min)
- Easy sampling and melt cleanliness assessment;
- Sensitive to the inclusions and oxide film
- Appropriately accurate
- Costly friendly
- Easy handling
- Portable

VAKUM YOĞUNLUK TEST CİHAZI VACUUM DENSITY TESTER



Labaratuvar Tipi Vakum Yoğunluk Test Cihazı

- Tam otomatik 80 mBar (+/- 1) sabit basınç
- Ayarlanabilir katılaşma zamanı
- Dokunmatik Operatör panel
- Tam Otomatik PLC ekran
- Kompakt tasarım
- Otomatik stop

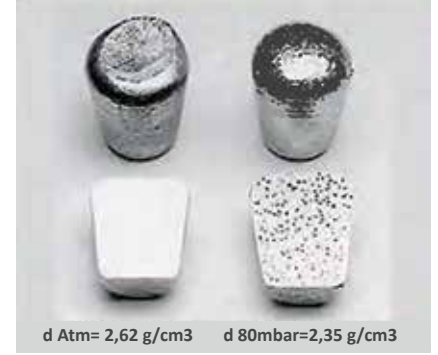

Weighing Model



•AVANTAJLAR

- Gaz alma ve Curüf alma işleminin doğruluğunun tespiti
- Poroziteden kaynaklanan döküm firelerinin bitmesi
- Döküm öncesi ergimiş metal kalitesinin ölçümü
- Yoğunluk indeksinin hesaplanarak porozitenin hesaplanması
- Yüksek kalite döküm, büyük tasarruf

•ADVANTAGES

- Determination of degassing and slagging off applications
- Measurement of melted metal before casting
- Calculation of the porosity by calculating the density index
- End of casting wastes due to the porosity
- High quality castings, big savings

POTANSİYEL POROZİTEYİ BELİRLEME

Yoğunluk İndeksi	<1	3	8	>12
Armosferik Basıncında Katılaşmış Numune				
80 m bar'da Katılaşmış Numune				

POROZİTE TİPİ ANALİZ

Serbest Hidrojen Etkisi	Mikro Çekme Etkisi	Serbest Hidrojen ve Mikro Çekmenin Ortak Etkisi	
0,482 ccm H/100g Al Yoğunluk İndeksi: 6,4	0,009 ccm H/100g Al Yoğunluk İndeksi: 5,8	0,295 ccm H/100g Al Yoğunluk İndeksi: 6,1	
Armosferik Basıncında Katılaşmış Numune			
80 m bar'da Katılaşmış Numune			

TAM OTOMATİK DÖVME YAĞLAMA ROBOTU
FULL AUTOMATIC FORGING LUBRICATION ROBOT



“Germany **tribo-chemie**
Trennen wie geschmiert
Environmental Forging Oils”

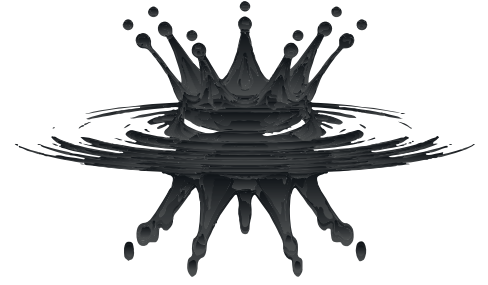

tribo-chemie
Trennen wie geschmiert
**LUBRICANTS
ARE USED
IN THIS MACHINE**



TEKNİK ÖZELLİKLER

- Sağlam gövde, her kalıba uygun şekilde kolay nozül montajı
- Linear, tek eksenli (dizayna bağlı çoklu eksen çalışabilir.)
- Yüksekliği Prese göre ayarlanabilir. (+/- 300 mm)
- İstenilen birçok noktada durma özelliği
- **7/24 Servis ve yedek parça desteği**
- 1 Yıl parça ve servis garantisi
- Tam otomatik, PLC Kontrollü
- Dokunmatik Kontrol Panel
- Servo Motor

TECHNICAL FEATURES

- Solid body, easy assembly of the nozzles to every type of presses
- Linear, single axle (multi-axis related with design.)
- Adjustable height according to the press (+/- 300mm)
- The feature to stop at various points
- **7/24 Service and spare part support**
- 1 year guarantee of service and spare part
- Full automatic, PLC controlled
- Touch Control Panel
- Servo motor

TAM OTOMATİK DOZAJLAMA SİSTEMLERİ FULL AUTOMATIC DOSING SYSTEMS

• TEKNİK ÖZELLİKLER

- Yağ varili için otomatik asansörlü sistem (seviye sensörü, otomatik devreye girme/çıkma)
- Dozajlama hattı ve tank için otomatik/manual temizleme sistemi
- İsteğe göre ayarlanabilir tank dolmuş başlangıcı ve dolmuş bitişi
- Gelen su miktarına göre çalışan servo kontrollü dozaj pompası
- Dokunmatik Kontrol Panel (**SIEMENS SIMATIC PANEL TOUCH**)
- Tam Otomatik PLC Kontrol (**SIEMENS SIMATIC S7 1200 PLC**)
- Devir ve seviye ayarlı yağ varili ve tank karıştırıcı
- Grafitli yağa uygun tasarım, minimum bakım
- 1:1-1:25'e kadar tam otomatik dozajlama
- Yağ varilinde homojen karışım elde etme
- 100-500 lt 316 kalite paslanmaz tank
- Sürücüler (**SIEMENS SINAMICS V20**)
- Yüksek hassasiyette debimetre
- Seviye sensörleri (varil ve tank)
- 2-6 bar karışım hat çıkışı
- Müşteriye özel dizayn

• TECHNICAL FEATURES

- Automatic lift system for lubricant drum (level sensor, automatic start-stop)
- Servo controlled dosing pump working according to the inlet water
- Lubricant tanks with speed and level sensor set and tank mixer
- Design suitable for graphite lubricant - minimum maintenance
- Automatic / Manual tank cleaning for dosing line and tank
- Full Automatic PLC Control (**SIEMENS SIMATIC S71200 PLC**)
- 306 grade stainless steel tank with 100 - 500 lt capacity
- Touch Control Panel (**SIEMENS SIMATIC PANEL TOUCH**)
- Homogenous mix inside the lubricant drum
- Touch Screen Panel for Operator - Siemens
- Level sensors (inside the drum & the tank)
- Adjustable Start and finish of tank filling
- Full automatic dosing up to 1:1 - 1:25
- Drivers (**SIEMENS SINAMICS V20**)
- Flowmeter with high precision
- Customer Specific design
- 2-6 bars Mix Line exit



PİSTOLE SPREY TABANCI
PISTOLE SPRAY GUNS

SPREY EL TABANCASI MOD. 080 - BORU UZUNLUĐU / HAND SPRAY GUNS MOD. 080 - PIPE LENGTH

Uzunluđu 25 cm'den 40 cm'ye Kadar Olan Boru Çeşitlerimiz
Types of Pipe Length from 25 cm to 40 cm

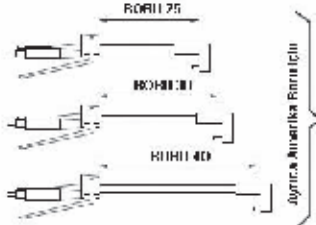

Uzunluđu 40 cm Üzerindeki Boru Çeşitlerimiz
Types of Pipe Length, Longer Than 40 cm

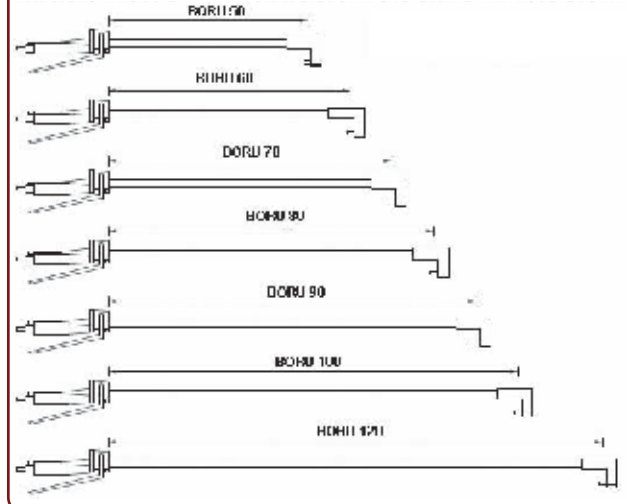

Mod. 080 TS - Mod. 081 TS
Mod. 080 TR - Mod. 081 TR
Mod. 080 AMERICA - Mod. 081 AMERICA

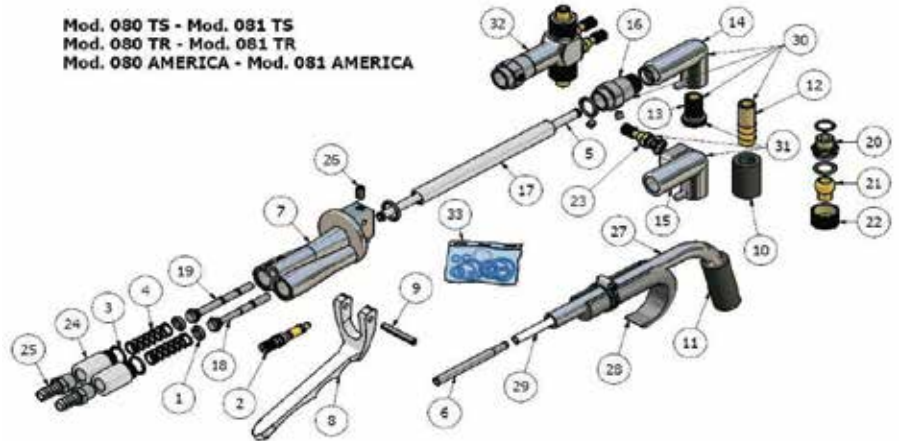

PİSTOLE SPREY TABANCALAR
PISTOLE SPRAY GUNS

SPREY EL TABANCASI MOD. 080 - BORU UZUNLUĞU / HAND SPRAY GUNS MOD. 080 - PIPE LENGTH

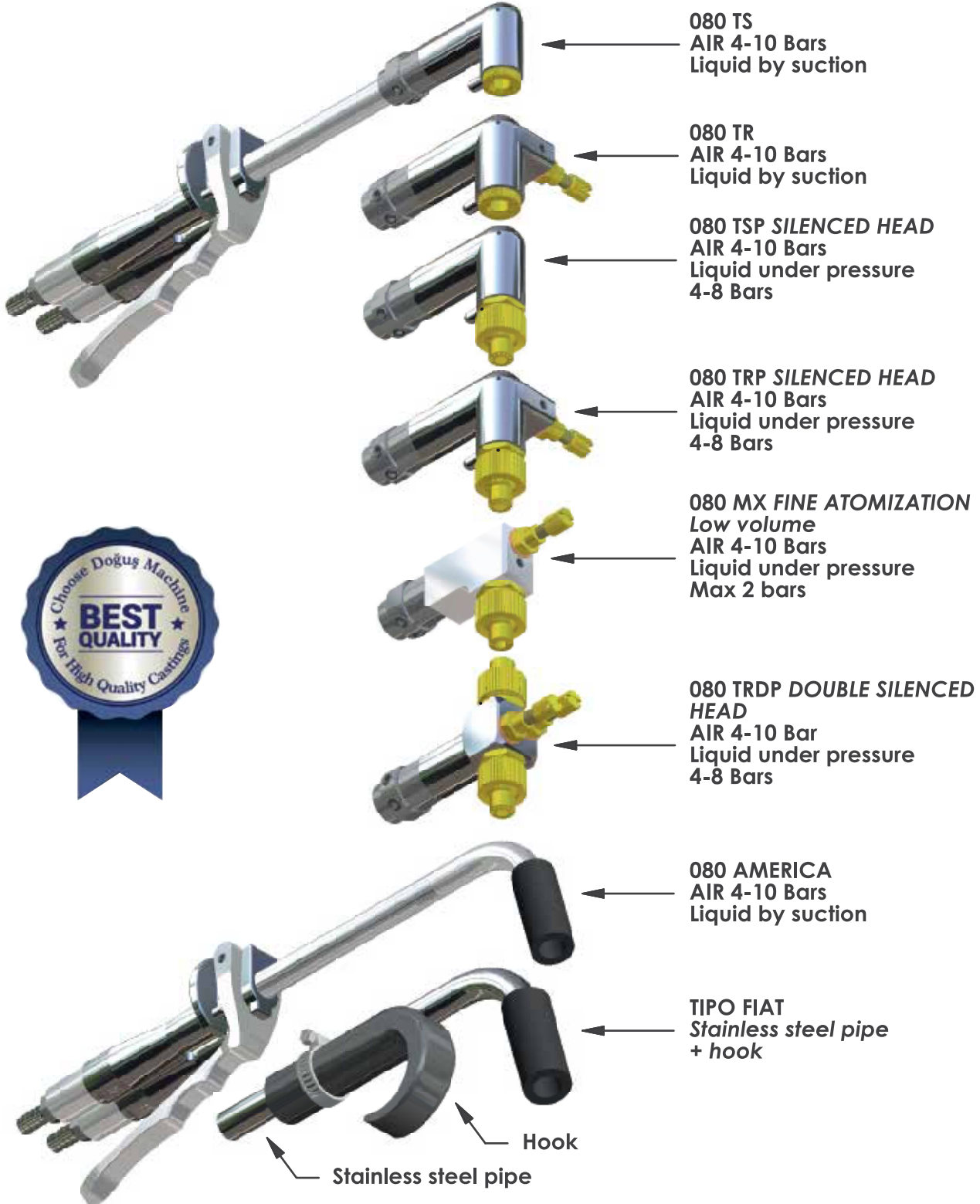

TAM OTOMATİK DOZAJLAMA SİSTEMLERİ

FULL AUTOMATIC DOSING SYSTEMS

• TEKNİK ÖZELLİKLER

- Tam Otomatik PLC Kontrol (**SIEMENS SIMATIC S71200 PLC**)
- Dokunmatik Kontrol Panel (**SIEMENS SIMATIC PANEL TOUCH**)
- Gelen su miktarına göre çalışan otomatik dozajlama pompaları
- Inverter kontrollü, devir ve seviye ayarlı mekanik karıştırma
- İstenilen miktarda tam otomatik dozajlama 100 L - 4000 L
- Hat çıkışında 3-10 Bar ayarlanabilir sabit Basınç Kontrolü
- İstenilen oranda tam otomatik dozajlama 1:20 - 1:250
- Inverter kontrollü, kademeli santrifüj pompalar
- Sürücüler (**SIEMENS SINAMICS V20**)
- Otomatik/Manual tank temizleme
- Aşırı dolum-taşma önleyici sistem
- Köpürme önleyici dolum sistemi
- Hacimsel yağ oranı kalibrasyonu
- Tank içi seviye tespit sensörleri
- IBC için seviye tespit sensörleri
- Tam otomatik bakteri temizliği
- Fabrika içi harici alarm-stop
- 4000 L Paslanmaz Tank
- Müşteriye özel dizayn
- 1 yıl parça garantili
- 2 adet hat çıkışı

• TECHNICAL FEATURES

- Full Automatic PLC Control (**SIEMENS SIMATIC S71200 PLC**)
- Touch Control Panel (**SIEMENS SIMATIC PANEL TOUCH**)
- Automatic dosing pumps working according to the inlet water
- Controlled by inverter; speed and level fixed mechanical stirring
- Full automatic dosing at desired quantity (400 it - 1.000 it)
- Fixed pressure control between 3-10 bars at the line exit
- Full automatic dosing at desired ratio (1 :20 - 1 :250)
- Controlled by inverter; multi-stage centrifugal pump
- Drivers (**SIEMENS SINAMICS V20**)
- Automatic / Manual tank cleaning
- System to prevent from filling to the brim & overflowing
- Calibration of lubricant ratio in volume
- Filling system to prevent foaming
- Level sensors inside the tank
- Level sensors for IBCs
- Full automatic bacteria cleaning
- External alarm & stop inside the factory
- 4.000 It stainless steel tank
- Customer Specific design
- 1 year-guarantee of parts
- 2 line exits



DOZAJLAMA VE KARIŞTIRMA ÜNİTELERİ

DOSING & MIXING UNITS



•AVANTAJLAR

- Dozajlama oranı 1:40 ile 1:200 arasında tam otomatik olarak ayarlanabilir
- Dozajlama ve karıştırma sarfiyata göre olacağı için yağda çöküntü ya da bakteri üremesi olmaz
- Kalıp ayırıcı basınç altında olduğu için yağlama otomatik yağlama sistemlerinde ya da nozüllü tabancalarla pulverize şeklinde spreyleme yapılabilir
- Dozajlama miktarı ayarlandıktan sonra dozajlama ve karıştırmayı sarfiyata göre otomatik yapar
- Su bazlı kalıp ayırıcı yağların dozajlamasında ve karıştırılmasında kullanılan tam otomatik bir sistemdir
- Yağ sarfiyatında azalma, yüksek verim

•ADVANTAGES

- A full automatic system used for dosing and mixing water based release agents
- The dosing ratio can be adjusted full automatically between 1:40 and 1:200
- After the dosing quantity is fixed, it performs the dosing and mixing automatically according to the consumption
- Since the dosing and mixing will be according to the consumption, no deposition or no bacterial growth is formed in the lubricant
- Since the release agent is under pressure, the lubrication can be performed in automatic lubrication systems or sprayed by spray guns with nozzles in a pulverized way
- Less lubricant consumption, higher productivity

DOZAJMATİK

DOSING SYSTEM



DOZAJMATİK

	MİNİDOZ 2,5 %	MİNİDOZ 10 %
Akış Debi Aralığı Fluid Flow Range	0,01 m ³ /h - 2,5 m ³ /h	0,01 m ³ /h - 2,2 m ³ /h
Enjeksiyon Oranı Injection Rate	0,5-2,5 % 1:200-1:40	2-10 % 1:50-1:10
Çalışma Basıncı Operating Pressure	0,5-9,5 Bar	0,5-5,5 Bar



TAM OTOMATİK AI-Zn BOR YAĞI DOZAJLAMA SİSTEMİ
FULL AUTOMATIC AI-ZN BORON OIL DOSING SYSTEMS



PATENTED
 PATENTED
 PRODUCT

CE

ISO
 9001:2015

KONTROL PANEL / CONTROL PANEL

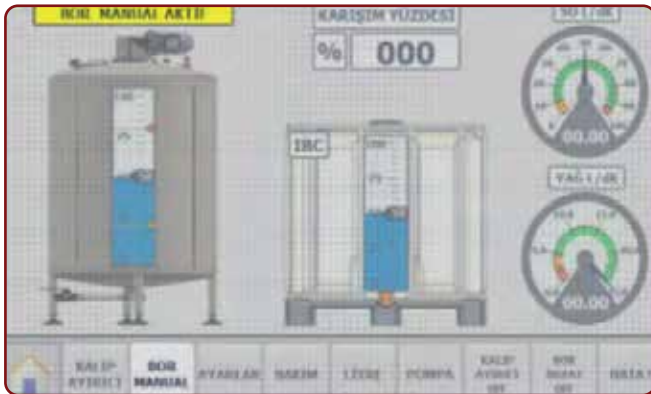
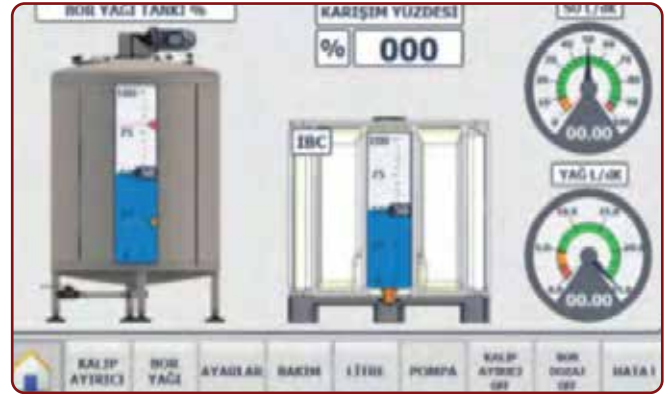
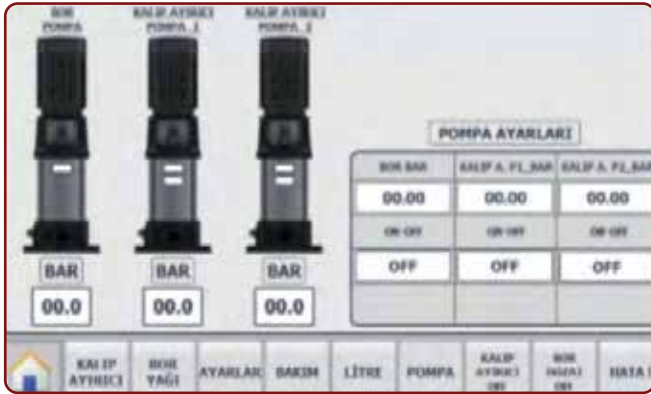

OTOMATİK PİSTON YAĞLAMA SİSTEMLERİ
AUTOMATIC PLUNGER LUBRICATION SYSTEMS

SIVI PİSTON YAĞLAMA / LIQUID PLUNGER LUBRICATION

DAMLATMA / DROP

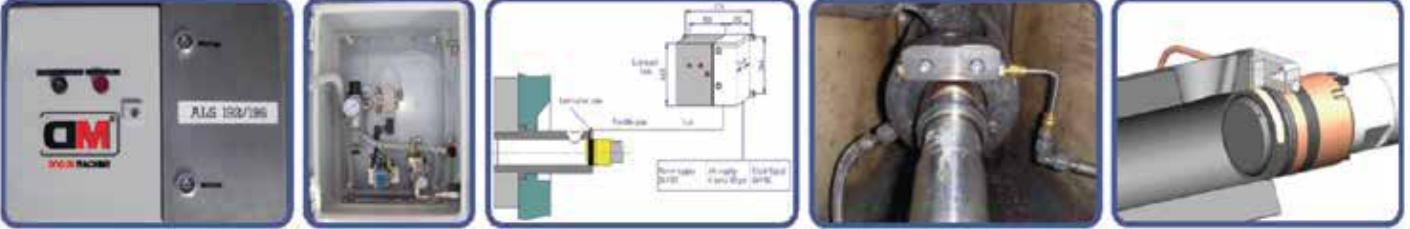

DAMLATMA & SPREY / DROP & SPRAY



BU MAKİNEDE
tribo-chemie
Trennen wie geschmiert
YAĞLARI
KULLANILMAKTADIR.

tribo-chemie
Trennen wie geschmiert
LUBRICANTS
ARE USED
IN THIS MACHINE

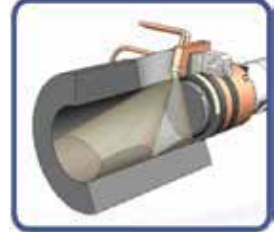

SPREY / SPRAY



BASIÇLI KARIŞIM TANKLARI
PRESSURIZED MIXTURE TANKS



PATENTED
PRODUCTS
SERIAL NO:
2014/ 10342

25lt

50lt

* Karıştırıcısız karışım tankı

•TEKNİK ÖZELLİKLER

- Otomatik yada manuel çalışma özelliği
- Çalışma Basıncı: maksimum 8 bar
- Çalışma Sıcaklığı: -20,+150 °C
- 24V DC standart elektrovalf
- Sıvı filtre (tannkın içinde)
- 25 ve 50 Lt kapasiteli
- Hava çıkış musluğu
- Hava giriş musluğu
- Sıvı çıkış musluğu
- Basınç regülatörü
- Geri dönüş valf
- Huni

•TECHNICAL FEATURES

- Automatic operation or manual operation
- Working pressure Max 8bar
- Working temperature -20, +150 °C
- 24 V DC standart elektrovalve
- Liquid filter (within the tank)
- Capacity 25 or 50 Lt
- Air outlet tap
- Air entry tap
- Liquid outlet tap
- Pressure regulator
- Non return valve
- Funnel

Mod. 020



Mod. AZ



Mod. AZ



Bağlantı Kolu



Lampojet 1-4XL



OTOMATİK PİSTON YAĞLAMA SİSTEMLERİ

AUTOMATIC PLUNGER LUBRICATION SYSTEMS

• AVANTAJLAR

- Pnömatik hareketli kolu sayesinde dozajlama borusunda tıkanma meydana gelmez.
- Granüllerin tamamen hassas bir şekilde Enjeksiyon Makinesinin kovanına otomatik olarak dozajlanmasında kullanılan dijital göstergeli granül atma makinesidir.
- PLC Kontrolü sayesinde granül miktardan istenilen miktarda ayarlanabilir.
- Düzenli ve istenilen miktarda doğru yağlama sonucu Piston ve Kovan ömürlerinde uzama.
- Zaman periyodu gibi havanın miktarı da dijital olarak ayarlanabilir.
- Dozajlama kolunun bütün pozisyonları ve hareketleri 3 boyutlu olarak ayarlanabilir.
- Yağ sarfiyatında azalma, yüksek verim.

• ADVANTAGES

- Thanks to its pneumatic moving arm, no blockage happens in the dosing tube.
- Bead dispenser with digital display used for automatically dosing the beads to the die-casting machine.
- The quantity of the beads can be adjusted to the desired level with its PLC control.
- The quantity of the air can be adjusted digitally as well as time period.
- The lifetime of plunger and sleeve can prolong due to the correct lubrication regularly and in desired quantity.
- All positions and movements of the dosing arm can be adjusted 3 dimensionally.
- Decrease in the consumption of lubricant, high productivity.

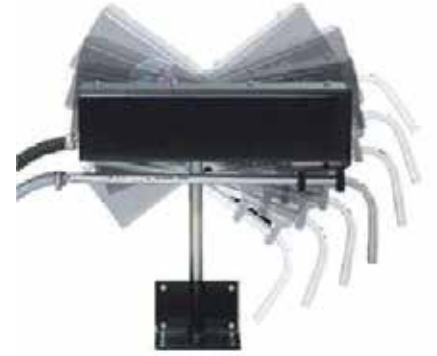

BU MAKİNEDEN
tribo-chemie
Trennen wie geschmiert
YAĞLARI
KULLANILMAKTADIR.

tribo-chemie
Trennen wie geschmiert
LUBRICANTS
ARE USED
IN THIS MACHINE



• TEKNİK ÖZELLİKLER

1. Kapasite : 6 lt
2. Çalışma Basıncı : 4-8 bar
3. Ağırlık : 15 kg
4. Çalışma : 24 Volt DC 4-5 sn (24-110 isteğe bağlı)
5. Uygunluk : Piston Yağlayıcı Granüller Ø 0,5 - 1 mm
6. Opsiyon : Pnömatik Dozajlama Kolu

• TECHNICAL FEATURES

1. Capacity : 6 lt
2. Working Pressure: 4-8 bar
3. Weight : 15 kg
4. Operation : 24 Volt DC 4-5 sn (24-110 optional)
5. Compatibility : Plunger Beads Ø 0,5-1 mm
6. Optionals : Pneumatic Dosing Arm

ALÇAK YÜKSEK BASINÇ ALÜMİNYUM KOKİL OTOMATİK KEPÇE SİSTEMLERİ
LOW HIGH PRESSURE GRAVITY AUTOMATIC LADLE SYSTEMS

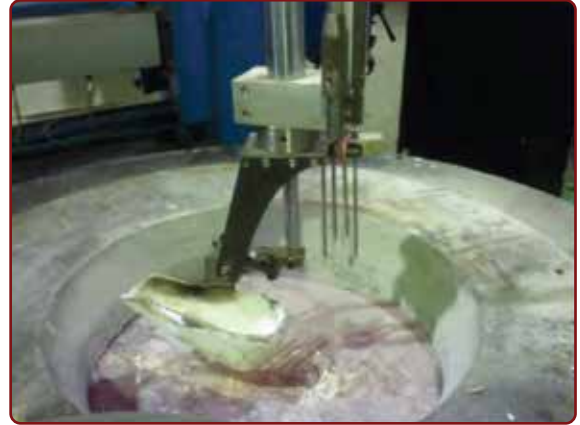

MODEL LINEER KEPÇE ALS-42 / MODEL LINEAR LADLE ALS-42

Voltaj <i>Voltage</i>	380V 50 Hz
Yardımcı Tehçizat Voltajı <i>Auxiliaries Voltage</i>	24 V ac
Kurulu Güç <i>Total Power</i>	3 KW
Kepçe Ağırlığı <i>Weight of the Ladle</i>	400 Kg
Yatay Eksen Uzunluğu <i>Length of Horizontal Axle</i>	4200 mm
Dikey Eksen Uzunluğu (Kepçe Hariç) <i>Length of Vertical Axle (except the spoon)</i>	2300 mm
Maksimum Yatay Hareket <i>Maximum Horizontal Position</i>	3400 mm
Maksimum Yatay Hız <i>Maximum Horizontal Speed</i>	1m/sn
Maksimum Dikey Hareket <i>Maximum Vertical Position</i>	1600 mm
Maksimum Dikey Hız <i>Maximum Vertical Speed</i>	0.18 m/sn
Maksimum Kepçe Hareketi <i>Maximum Spoon Position</i>	220 mm
Maksimum Kepçe Hızı <i>Maximum Spoon Speed</i>	0.05 m/sn
Maksimum Taşıma Ağırlığı (Kepçe + Materyal) <i>Maximum Transportable Weight (Spoon + Material)</i>	50 Kg



•TEKNİK ÖZELLİKLER

•TECHNICAL FEATURES

- Dokunmatik Kontrol Panel (**SIEMENS SIMATIC PANEL TOUCH**)
- Full Otomatik PLC Kontrol (**SIEMENS SIMATIC S7 1200 PLC**)
- Tüm hareketlerde Emniyet swicleri ve sensörleri ile desteklenen güvenlik
- 0,1 Kg.dan 50 Kg.'a kadar metal taşıma kapasitesi
- Üretim rakamlarında % 50'ye varan artışlar
- Isıya ve sürtünmeye dayanıklı yataklar
- Sürücüler (**SIEMENS SINAMICS V20**)
- Hızı sayesinde kısalan çevrim süresi
- Farklı kalıplar için 5 ayrı alt program
- Tüm hareketler Encoder kontrollü
- Manuel Operatör Kontrol Panel
- Alüminyum Gövde ve eksenler
- Düşük enerji ve işçilik maliyeti
- Linear 2 Eksen

- Full Automatic PLC Control (**SIEMENS SIMATIC S71200 PLC**)
- Touch Control Panel (**SIEMENS SIMATIC PANEL TOUCH**)
- Drivers (**SIEMENS SINAMICS V20**)
- 5 different sub-program for different dies
- 2 different linear axes
- Manual Control Panel
- All the positions controlled by Encoder
- Safety supported by safety switches and sensors for all the positions.
- Aluminium frame and axes
- Temperature and abrasion resistant supports
- Less cycle times thanks to the speed
- Hızı sayesinde kısalan çevrim süresi
- Metal transport capacity from 0,1 kg to 50,00kg
- Increase in the production figures up to 50%
- Decrease in the labor and energy costs

ALÇAK YÜKSEK BASINÇ ALÜMİNYUM KOKİL OTOMATİK KEPÇE SİSTEMLERİ
LOW HIGH PRESSURE GRAVITY AUTOMATIC LADLE SYSTEMS



YÜKSEK BASINÇLI DÖKÜM OTOMATİK KALIP YAĞLAMA SİSTEMLERİ

HIGH PRESSURE CASTING AUTOMATIC MOLD LUBRICATION SYSTEMS

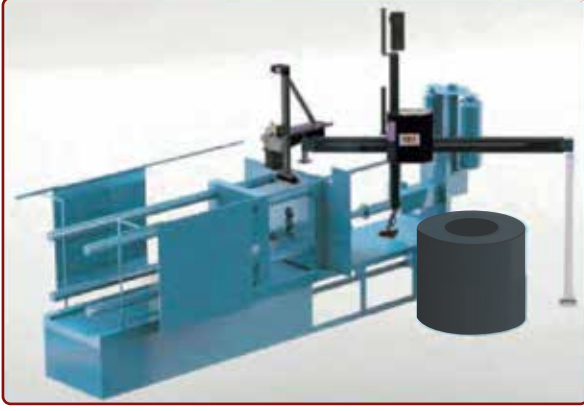

METAL ENJEKSİYON PRESİ EKİPMANLARI / METAL INJECTION PRESS EQUIPMENT

METAL ENJEKSİYON PRESİ

METAL INJECTION PRESS

	160 (t)	200 (t)	300 (t)	400 (t)	550 (t)	750 (t)
Kapama Kuvveti <i>Locking Force</i>	1800kN	2200kN	3200kN	4200kN	5700kN	7700kN
Maksimum Gezer Plaka Hareketi <i>Maximum Platen Stroke</i>	400mm	440mm	450mm	600mm	750mm	850mm
İtici Kuvvet <i>Ejector Force</i>	130kN	130kN	160kN	200kN	280kN	370kN
İtici Strok <i>Ejector Stroke</i>	90mm	100mm	120mm	150mm	180mm	200mm
Enjeksiyon Kuvveti <i>Injection Force</i>	225kN	250kN	340kN	500kN	600kN	650kN
Enjeksiyon Strok <i>Injection Stroke</i>	400mm	400mm	475mm	475mm	550mm	550mm
Maksimum Parça Aralığı <i>Maximum Shot Weight (Al)</i>	1.800gr	2.500gr	4.000gr	5.000gr	7.200gr	10.000gr.
Motor Gücü <i>Motor Rating</i>	15kW	15kW	15kW	22kW	30kW	30kW



Kepçe Modelleri



Püskürtücüler



Çıkarıcılar



Kontrol Sistemleri

YÜKSEK BASINÇLI DÖKÜM OTOMATİK KALIP YAĞLAMA SİSTEMLERİ

HIGH PRESSURE CASTING AUTOMATIC MOLD LUBRICATION SYSTEMS

KONTROL VE PROGRAMLAMA / CONTROL AND PROGRAMMING

- Püskürtme sırasında çekirdek ve pimleri kontrol etmek için kalıp döküm makinesiyle arayüz
 - Kullanıcı dostu kontrol ünitesi - püskürtücülerin basit bir şekilde pozisyon almasını sağlar
 - Ayarlanabilir 3 + 3 bant püskürtme kafası
 - 100 püskürtme programına kadar
 - Teach-pendant kontrolü
 - Robotik kontrolör
- Interface with die casting machine to control cores and pins while spraying
 - User-friendly and learning-mode control unit allows the sprayer to be adjusted by simply teaching the position
 - Adjustable 3+3 band spraying head
 - Up to 100 spray programs
 - Teach-pendant control
 - Robotic controller



OTOMATİK YAĞLAMA SİSTEMİ / AUTOMATIC LUBRICATION SYSTEM

Voltaj <i>Voltage</i>	380V 50 Hz
Yardımcı Tehçizat Voltajı <i>Auxiliaries Voltage</i>	24 V ac
Kurulu Güç <i>Total Power</i>	3KW
Toplam Ağırlık <i>Total Weight</i>	200Kg
Yatay Eksen Uzunluğu <i>Length of Horizontal Axle</i>	1200mm
Dikey Eksen Uzunluğu (Kepçe Hariç) <i>Lenght of Vertical Axle (except the spoon)</i>	1400mm
Maksimum Yatay Hareket <i>Maximum Horizontal Position</i>	800mm
Maksimum Yatay Hız <i>Maximum Horizontal Speed</i>	1 m/sn
Maksimum Dikey Hareket <i>Maximum Vertical Position</i>	1000mm
Maksimum Dikey Hız <i>Maximum Vertical Speed</i>	1 m/sn

YÜKSEK BASINÇLI DÖKÜM OTOMATİK KALIP YAĞLAMA SİSTEMLERİ

HIGH PRESSURE CASTING AUTOMATIC MOLD LUBRICATION SYSTEMS

•TEKNİK ÖZELLİKLER

- Özel istekleriniz için özel olarak tasarlanmış kafa ve nozüller
- Güncelleme ve sorun giderme için uzaktan erişim (standart)
- Kalıp ısı dağılımı ile uyumlu akıllı yağlama ayarı (opsiyonel)
- Güçlü dişli sistemi uzun ömür ve minimum titreşim sağlar
- Kaymalı (mil) yatakları için bağımsız merkezi yağlama sistemi
- Yataklar ve takozlar için bağımsız otomatik merkezi yağlama sistemi
- Valfler ve borular, püskürtme kafasındaki sızıntıları önleyecek şekilde tasarlanmış ve takılmıştır
- Lineer Makaralı Rulmanlar ve Kılavuz Raylar
- Bakım için tüm bileşenlere kolay erişim
- Sertleştirilmiş ve zemin raf ve pinyonu
- Yüksek performanslı servo motorlar
- Standart 3+3 bant püskürtme kafası
- Modüler püskürtme kafası tasarımı
- Güçlü hava akışı ve sprey
- Hassas konumlandırma
- Akış kontrol nozülleri

•TECHNICAL FEATURES

- Tailer made head & nozzle designed for your special requirements
- Remote access for update and troubleshooting (standart)
- Intelligent lubrication setting in accordance with die thermal distribution (optional)
- The heavy-duty gear system ensures long life and minimum vibration
- Independed central lubrication system for slides an bearings
- Independent automatic central lubrication system for skids and bearings
- Valves and pipes are designed and fitted to prevent leaks in the spray head
- Linear roller bearings and guideways
- Easy access to all components for maintenance
- Hardened & ground rack and pinion
- High-performance servo motor motors
- Standard 3+3 band spraying head
- Modular spray head design
- Powerful air flow and spray
- Precise positioning
- Flow control nozzles

"Güçlü servo motorlar maksimum hız ve minimum bakım gerektirir"
"Powerful servo motors ensures maximum speed and require minimum maintenance"

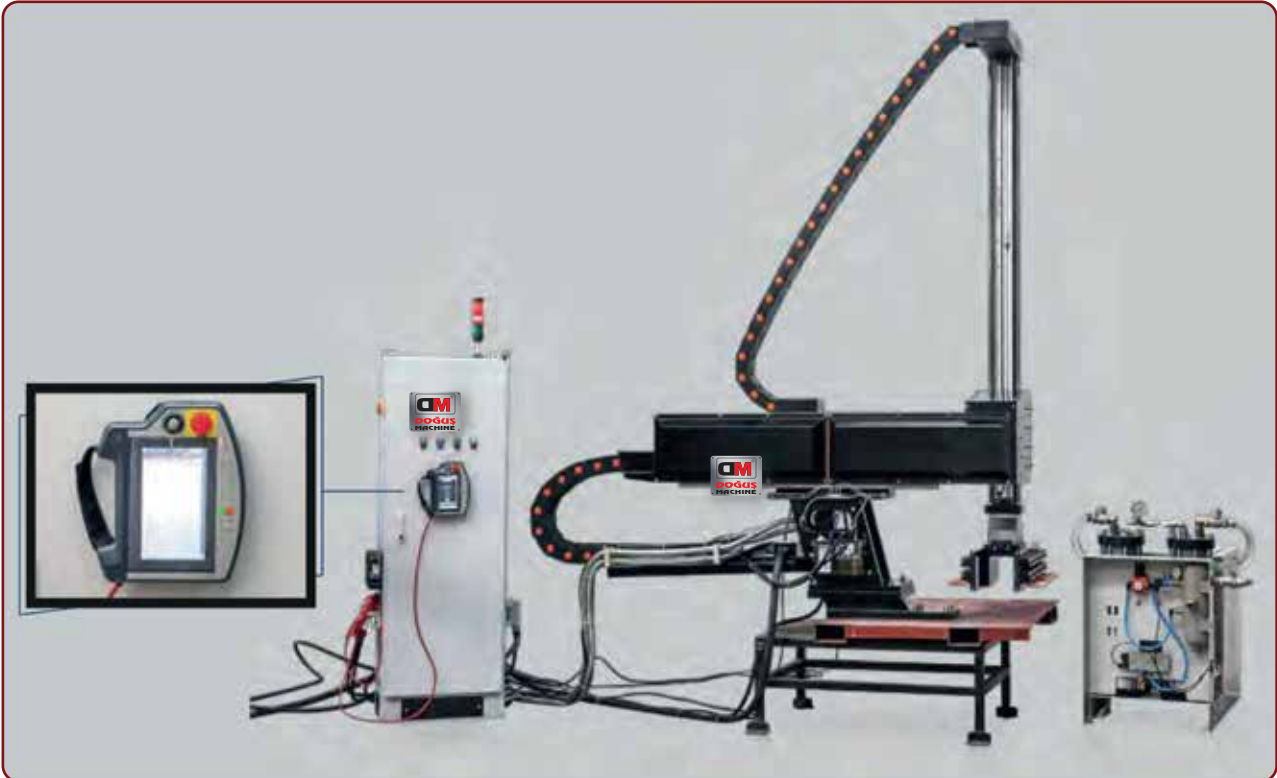

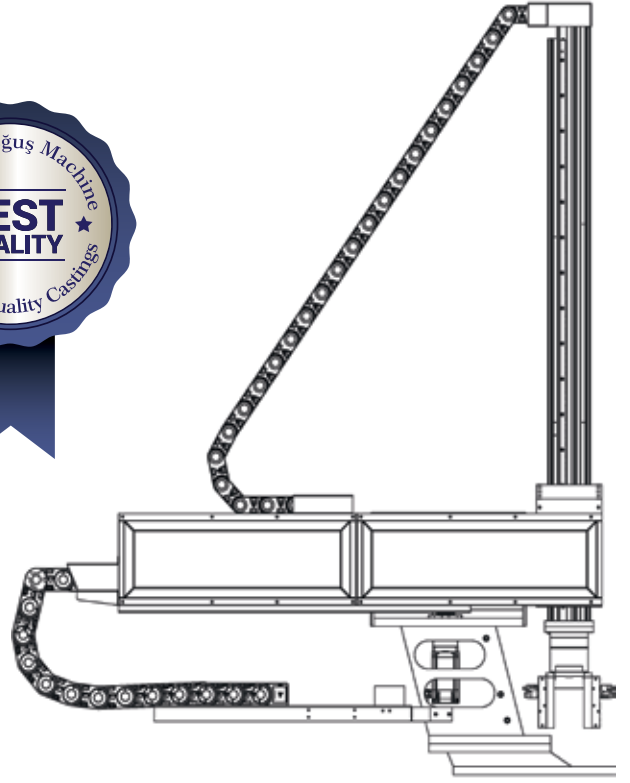
YÜKSEK BASINÇLI DÖKÜM OTOMATİK KALIP YAĞLAMA SİSTEMLERİ
HIGH PRESSURE CASTING AUTOMATIC MOLD LUBRICATION SYSTEMS

	SL-01	SL-02	SL-03	SL-04
ORANSAL SIKIŞTIRMA (TON) CLAMPING FOR RANGE (TONS)	13-140	450-750	1000-1250	1600-2500
YATAY EKSEK HORIZONTAL AXIS				
YATAY STROK (mm) HORIZONTAL STROK (mm)	400	800	1000	1000
YATAY HIZ (mm/sn) HORIZONTAL SPEED (mm/sn)	1	1	1	1
DİKEY EKSEN VERTICAL AXIS				
DİKEY STROK (mm) VERTICAL STROK (mm)	800	1400	1600	2400
DİKEY HIZ (mm/sn) VERTICAL SPEED (mm/sn)	1	1	1-1,5	1-1,5
MAKSİMUM TAŞIMA KAPASİTESİ (kg) MAXIMUM PAYLOAD (kg)	15	25	35	60
PÜSKÜRTME DEVRE SAYISI NUMBER OF SPRAYING CIRCUITS	2	6	6	6
NOZÜL SAYISI NUMBER OF NOZZLE	12	18-20-24	24-32	60-80
KONTROLÖR CONTROLLER				
KONTROL PANELİ CONTROL PANEL	ok	ok	ok	ok
EKRAN ÖLÇÜSÜ SCREEN SIZE	7"	7"	11,6	11,6
MOTOR MOTOR				
TAHRİK DRIVE	ac servo	ac servo	ac servo	ac servo

GAZ VEYA ELEKTRİK ISITMALI HİDROLİK DEVİRMELİ ALÜMİNYUM ERGİTME FIRINLARI

GAS OR ELECTRICAL HEATED HYDROLIC TILTING ALUMINIUM ELTING FURNACES



Gas or Electrical Heated Hydraulic Tilted Aluminium Melting Furnaces



SİC POTA / SİC CRUCIBLE

No	H mm	D mm	d mm	L mm	h mm	Al Kg	Cu Kg	Zn Kg
TP 287	600	525	305	130	-	200	655	495
TP 387	630	615	355	160	400	300	995	750
TP 412	800	615	355	160	570	375	1245	935
TP 412 H/3	850	615	355	160	-	400	1315	990
TP 412 H	900	615	355	160	620	420	1390	1045
TP 487	800	720	360	200	-	525	1730	1300
TP 489	940	720	360	200	-	610	2007	1510
TP 490	1050	720	360	200	-	675	2225	1675
TP 587	900	780	435	200	550	720	2375	1785
TP 1500	850	840	350	200	-	760	2515	1890
TP 587 H	1000	780	435	200	620	795	2620	1970
TP 1800	980	840	350	200	-	865	2855	2150
TP 750	880	880	350	200	-	865	2860	2150
TP 800	1000	880	350	200	570	970	3200	2410
TP 2100	1130	840	350	200	-	985	3250	2445
TP 800 H/4	1100	880	350	200	620	1060	3490	2625
TP 800 H/2	1170	880	350	200	700	1120	3690	2780
TP 900	1000	950	440	200	570	1185	3905	2940
TP 800 H	1250	880	350	200	750	1190	3920	2950
TP 900 H/4	1100	950	440	200	620	1290	4260	3210
TP 800 H/14	1400	880	350	200	900	1320	4355	3275
TP 900 H	1250	950	440	200	700	1455	4800	3610

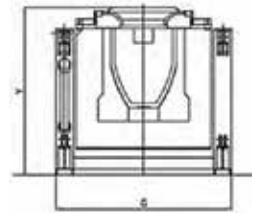
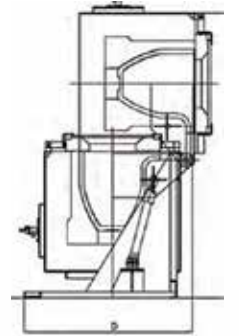

Tip Type	Pota Crucible	Eriyik Molten (Tmax)	Güç Power (max)	Dış Boyutlar Outer Dimensions			
				G(mm)	D(mm)	Y(mm)	H(mm)
TGM-350/28	TP-412	800 C	320 kW 275.000 kCal/h	2000	1950	1800	3200
TGM-600/38	TP-587	800 C	450 kW 387.000 kCal/h	2100	2050	1900	3350
TGM-800/54	TP-800	800 C	630 kW 542.000 kCal/h	2200	2150	1950	3450

Tip Type	Pota Crucible	Eriyik Molten (Tmax)	Güç Power (max)	Dış Boyutlar Outer Dimensions			
				G(mm)	D(mm)	Y(mm)	H(mm)
TEM-800/54	TP-800	800 C	99 kW 400 V 3 ph/N	2100	2150	200	3500

MAMMUT-WETRO
Schmelzteilwerk GmbH

ORJİNAL ALMAN MAMMUT-WETRO
ERGİTME POTALLARI

GAZ VEYA ELEKTRİK ISITMALI HİDROLİK DEVİRMELİ ALÜMİNYUM ERGİTME FIRINLARI

GAS OR ELECTRICAL HEATED HYDROLIC TILTING ALUMINIUM ELTING FURNACES



SİC POTA / SIC CRUCIBLE



NO	H mm	D mm	d mm	h mm	Al Kg	Cu Kg	Zn Kg
BU 200	600	525	305	410	210	690	520
BU 250	630	615	355	400	315	1040	785
BU 300	700	615	355	450	350	1150	865
BU 350	800	615	355	570	395	1300	980
BU 350 H/3	850	615	355	-	415	1375	1035
BU 350 H	900	615	355	-	440	1450	1090
BU 500	750	775	435	450	600	1975	1490
BU 600	900	780	435	550	720	2375	1785
BU 700	1000	780	435	620	795	2620	1975
BU 750	880	880	450	400	905	2985	2250
BM 800 H/1	1000	880	350	570	970	3200	2400
BM 800 H/4	1100	880	350	620	1060	3490	2625
BM 800 H/2	1170	880	350	700	1120	3690	2780
BU 900	1000	950	440	570	1185	3905	2940
BM 800 H	1250	880	350	750	1190	3920	2950
BU 900 H/4	1100	950	440	620	1290	4260	3210
BM 800 H/14	1400	880	350	900	1320	4355	3280
BU 900 H	1250	950	440	700	1455	4800	3610

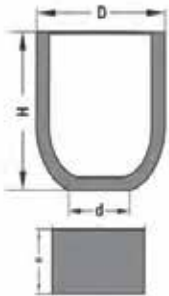

GAZLI OCAKLAR GAS FURNACES

Tip Type	Pota Crucible	Eriyik Molten (Tmax)	Güç Power (max)	Dış Boyutlar Outer Dimensions		
				G(mm)	Y1(mm)	Y2(mm)
SGM-350/20	BUX-300	800 °C	230 kW 198.000 kCal/h	1530	1200	2400
SGM-350/28	BUX-350	800 °C	320 kW 275.000 kCal/h	1530	1300	2500
SGM-500/28	BUX-500	800 °C	320 kW 275.000 kCal/h	1630	1300	2500
SGM-600/38	BUX-600	800 °C	450 kW 387.000 kCal/h	1630	1450	2550
SGM-800/48	BUX-800	800 °C	550 kW 473.000 kCal/h	1900	1805	2800

ELEKTRİKLİ OCAKLAR ELECTRICAL FURNACES

Tip Type	Pota Crucible	Eriyik Molten (Tmax)	Güç Power (max)	Dış Boyutlar Outer Dimensions		
				G(mm)	Y1(mm)	Y2(mm)
SEM-200/30	BU-200	800 °C	30 kW 400 V 3 PH/N	1205	990	1300
SEM-300/33	BU-300	800 °C	35 kW 400 V 3 PH/N	1380	1130	1420
SEM-350/33	BU-350	800 °C	40 kW 400 V 3 PH/N	1380	1230	1520
SEM-500/82	BU-600	800 °C	95 kW 400 V 3PH/N	1680	1530	1880

MAMMUT-WETRO
Schmelztiigelwerk GmbH

ORJİNAL ALMAN MAMMUT-WETRO
ERGİTME POTALARI

TAV FIRINLARI, KONVEYÖR SİSTEMLERİ, DÖNER OCAK SİSTEMLERİ

ANNEALING FURNACES, CONVEYOR SYSTEMS, ROTARY FURNACE SYSTEMS



DEVİRMELİ DÖNER TİP ERGİTME FIRINI
TILTING ROTARY TYPE MELTING FURNACE**•TEKNİK ÖZELLİKLER**

- Oksi-yakıt, yakıt yağ veya doğalgaz içeren yanma sistemi
- HMI arayüzlü PLC kontrollü işletim sistemi
- Hidrolik kontrollü devirme ve kapı sistemi
- Maksimum sıcaklık: 950° C
- Redüktörlü döner sistem
- 1-20 ton arası kapasite

•TECHNICAL FEATURES

- Combustion system with oxy-fuel, fuel-oil or NG
- PLC controlled operating system with HMI interface
- Hydraulic controlled tilting and door system
- Max. temperature: 950° C
- Rotating system with reducer
- Between 1-20 ton capacity



Devirmeli Döner Tip Ergitme Fırını
Tilting Rotary Type Melting Furnace



Külçe Döküm Makinesi
Ingot Casting Machine

KÜLÇE DÖKÜM MAKİNESİ
INGOT CASTING MACHINE**•TEKNİK ÖZELLİKLER**

- Otomatik istifleme, sıyırma ve işaretleme sistemi
- Tandış ve kalıp ön ısıtma sistemi
- Külçe kalıpları ve döküm çarkı
- 100-300 arası kalıp kapasitesi
- Döküm makinesi konveyörü
- Hız kontrollü döküm ünitesi
- Hava ve su soğutma sistemi
- Külçe çıkarma cihazı

•TECHNICAL FEATURES

- Automatic stacking, stripping and marking system
- Tandish and mould pre-heating system
- Ingot moulds and casting wheel
- Between 100-300 mould capacity
- Casting machine conveyor
- Casting drive unit with speed control
- Air and water cooling system
- Ingot knockout device

REVERBER TİPİ ERGİTME & BEKLETME OCAKLARI

REVERBERATORY TYPE MELTING & HOLDING FURNACES

• TEKNİK ÖZELLİKLER

- 5-60 ton arası kapasite
- Düşük enerji tüketimli yeni teknoloji rejeneratif veya soğuk brülör ısıtma sistemi
- Gaz tüketimi < 75Nm³NG/Ton Al
- Dayanıklı çelik gövdeli sağlam yapı
- %85 Al₂O₃ alümina yapışmaz dökme refrakter. Korundum birikmez.
- Hidrolik silindirle çalışan ana kapı
- Hidrolik devirme silindiri
- Pnömatik çalışan kapı kilitleme sistemi
- Hava soğutmalı egzoz damperli
- Manyetik veya gözenekli tapa alüminyum karıştırıcı sistemi
- PLC ve HMI ile kontrol

• TECHNICAL FEATURES

- Between 5-60 ton capacity
- New technology regenerative or cold burner heating system with low energy consumption
- Gas consumption <75Nm³NG/Ton Al.
- Rigit construction with robust steel body
- %85 Al₂O₃ alumina non-stick cast refractory. No corundum builds up
- Hydraulic cylinder driven main door
- Hydraulic tilting cylinder
- Pneumatic driven door clamping system
- Air cooled exhaust damper
- Magnetic or porous plug aluminium stirrer system
- Control with PLC and HMI



BİYET HOMOJENİZASYON FIRINLARI

BILLET HOMOGENISING FURNACES

• TEKNİK ÖZELLİKLER

- 5-60 kapasite
- Çalışma sıcaklığı: 5800° C Homojenlik: ±50C
- Rejeneratif ve soğuk brülör sistemleri
- Gaz tüketimi: < 30Nm3 NG/Ton Al
- Çift yönlü veya tek yönlü hava sirkülasyonu
- Isıtma süresi: Biyet çapına bağlı olarak 8-11 saat
- E-motor redüktörü ile çalışan kapı
- Pnömatik çalışan kapı kilitleme sistemi
- Patlamaya karşı koruma pencereleri
- Soğutma kabini
- Tersinir hava akış soğutma sistemi
- Soğutma hızı 4000 C/saat' e kadar

• TECHNICAL FEATURES

- 5-60 capacity
- Working temperature: 5800°C. Homogeneity:±50C
- Regenerative and cold burner systems
- Gas consumption <30Nm3 NG/Ton Al.
- Double way or one way air circulation
- Heating time: 8-11 hour depends on billet diameter
- E-motor reducer driven door
- Pneumatic actuated door locking system
- Explosion protection windows
- Cooling cabinet
- Reversible air flow cooling system
- Cooling rate up to 4000C/h.



Biyet Homojenizasyon Fırınları
Billet Homogenising Furnaces



Otomatik Biyet İstifleyici & İstif Bozucu Sistem
Automatic Billet Stacker & Destacker System

OTOMATİK BİYET İSTİFLEYİCİ & İSTİF BOZUCU SİSTEM

AUTOMATIC BILLET STACKER & DESTACKER SYSTEM

• TEKNİK ÖZELLİKLER

- İstifleme ve istif bozma süresi < 2 saat
- Bir yaygın yükleme ve boşaltma sistemi 4 fırına kadar hizmet verebilir
- E-motor redüktör tahrikli halat kaldırma sistemi
- E-motor redüktör tahrikli hareket sistemi
- Pnömatik tahrikli nokta sistemi
- Biyet otomatik olarak soğuk testere makinesine tek tek aktarılır
- Otomatik kontrol sistemi

• TECHNICAL FEATURES

- Stacking and de-stacking time <2 hours
- One common loading & unloading system can serve up to 4 furnaces
- E-motor reduces driven rope lifting system
- E-motor reducer driven movement system
- Pneumatic driven point system
- Billets are automatically transferred to the cold saw machine one by one
- Automatic control system

ASTAR DÖVME SİSTEMLERİ REFRACTORY RAMMING SYSTEMS



• AVANTAJLAR

- Astar malzemenin şablon çevresinde, eşit yoğunlukta sıkıştırılmasını sağlar. Bu sayede indüksiyon ocağı iç çevresindeki aşınma eşit olacaktır.
- Oluşabilecek çatlaklar, gaz boşlukları gibi riskler azalır.
- Astarlama işlemi diğer eski yöntemlere göre çok daha kısa sürede tamamlanır.
- Astarlama işleminin kısılması ile daha fazla metal eritilebileceğinden ocağın verimi artar
- İş gücü daha ekonomik bir şekilde kullanılmış olur.
- Düşük kapasiteli ocaklarda kullanıma uygundur.
- Otomatik vinç aparatı ilavesiyle işlem, tam otomatik olarak gerçekleştirilebilir

• ADVANTAGES

- Compacts refractory material with equal density which causes similar melt penetration on inner surface of refractory.
- Remove risks such as cracks and gas pockets on refractory.
- Completes ramming operation in a very short time.
- More melting done with time saving.
- Manpower is used more efficient and economic.
- Suitable for small or large furnaces.
- Operation is done fully automatic with automatic crane device.



TAŞIMA VE İŞLEM POTALARI
TRANSFER AND TREATMENT LADLES



•AVANTAJLAR

- Opsiyonel forklift ataşmanı sayesinde vinç gereksinimi olmadan forkliftle döküm yapılabilir.
- Özel tasarımıımız oto-blokajlı redüktörler kullanılarak güvenlik sorunları ortadan kaldırılmış ve kullanım kolaylığı artırılmıştır.
- Sağlam çelik konstrüksiyonu pota ömrünü uzun kılar ve üstün güvenlik sağlar.
- Tüm döküm potaları Avrupa Standartları'na uygun şekilde tasarlanıp imal edilmiştir.
- Opsiyonel vinç koruyucu üst plaka, taşıyıcı vincin döküm sıcaklığından etkilenmesini önler.
- Çelik astarlama şablonuyla, en kısa sürede pratik astarlama imkanı.

•ADVANTAGES

- All foundry ladles are designed and manufactured in European Standards.
- Security problems are avoided by using our designed and manufactured self-locking steering hub (reduction gears).
- Steel made lining former ensures practical and fast lining.
- Rigid steel body structure extends ladle's lifetime and maximizes safety.
- Ladle could be used by forklift by using optional forklift attachment.
- Optional crane protection shield avoids damages on crane caused by melt temperature.



TAŞIMA VE İŞLEM POTALARI

TRANSFER AND TREATMENT LADLES



•TEKNİK ÖZELLİKLER

- Ergimiş alüminyum taşıma kapasitesi 350 kg
- Her türlü ataçmana uyumlu olarak imal edilebilir
- Kolay bakım ve temizlik
- İnsural pota
- Çelik gövde

•TECHNICAL FEATURES

- Melting Aluminum Carrying Capacity 350 kg
- It can be produced in accordance with all types of attachments
- Easy maintenance and cleaning
- Insural crucible
- Steel body

HİDROLİKLİ TAŞIMA VE İŞLEM POTALARI

HYDRAULIC TRANSFER AND TREATMENT LADLES



•TEKNİK ÖZELLİKLER

- Ergimiş alüminyum taşıma kapasitesi 1000 kg
- Transfer potası dolu toplam ağırlık 3850 kg
- Hidrolik sistemli dökülebilir pota
- Kolay sökülebilir, hareketli gaga
- Hidrolik sistemli açılabilir kapak
- Çalışma basıncı 120 Bar
- Yalıtımlı pota ve kapak

•TECHNICAL FEATURES

- Melting aluminum carrying capacity 1000 kg
- Transfer crucible full weight 3850 kg
- Purable crucible with hydraulic system
- Easy to remove, moveable beak
- Opening cover with hydraulic system
- Working pressure 120 bar
- Insulated crucible and cover

POTA TAŞIMA ATASMANI TRANSFER LADLE ATTACHMENT



•AVANTAJLAR

- Taşıma potasını; öne, sağa, sola dönmek için kullanılır.
- Forkliftte bağlı olarak çalışan hidrolik bir ekipmandır.
- Minimum 3,5 ton taşıma kapasitesine sahip tüm forklifler için uygundur

•ADVANTAGES

- It is a hydraulic equipment which is connected to the forklift
- Used for pouring the ladle forward, right, left
- Suitable for all forklift with a minimum payload of 3,5 tonnes

OTOMATİK DÖKÜM POTASI AUTOMATIC POURING LADLE

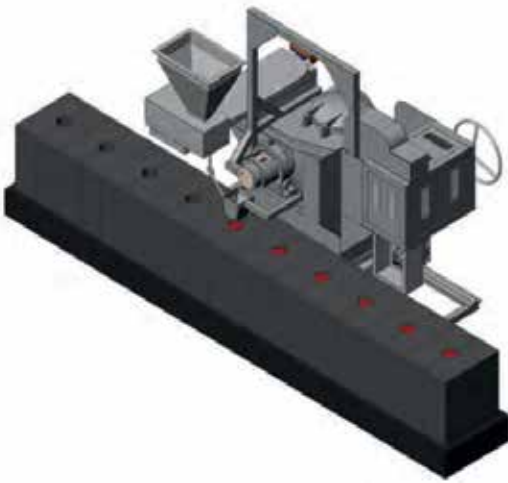

•TEKNİK ÖZELLİKLER

- Sıvı metal içerisinde herhangi bir türbülansa neden olmaz.
- Hareketler mekanik olarak tasarlanmış olup, hassas pozisyonlama gerçekleştirilmektedir.
- Basınç olmadığı ve serbest döküş sağlandığı için kalıp içerisinde herhangi bir erozyon yaratmaz.
- Metal serbest akışla döküldüğü için, diğer basınçlı sistemlere göre daha az metal sıçratır.
- Isının düşmesi durumunda, içindeki sıvı metal bir taşıma potasına dökülerek boşaltılabilir ve yeniden sıcak metal alınabilir.
- Sıvı metalin akış hızı, döküm süreleri, döküm miktarı, pota devirme açısı ile PLC olarak kumanda edilmektedir. Lazer seviye ölçümü gibi elektronik bir sisteme ihtiyaç yoktur.
- Tasarımının en önemli özelliklerinden biri sistemin tamamen mekanik oluşudur. Elektrik kesilmesi gibi zorunlu durumlarda direksiyon aracılığı ile manuel kullanılabilir. İçindeki sıvı metal, bir taşıma potasına dökülerek boşaltılabilir

•TECHNICAL FEATURES

- It does not cause turbulence in molten metal cause there is no strong flow changes like open/close loops.
- Movements are mechanically designed and accurate positioning is provided. Easy to interfere in emergency cases.
- Causes no erosion on sand mold because metal flows freely without pressure.
- It has less spattering while pouring compared to other similar systems works under pressure.
- Molten metal could be taken out easily from the spout behind the system when temperature goes under desired level or in emergency cases
- Flow rate and duration, pouring amount and tilting angle are controlled by PLC control system. No need to have any other level meter such as laser systems.
- One of the most important design feature is system is completely mechanical. In electricity cut down scenerios steering wheel rotates reservoir manually to take metal out.

İNDÜKSİYON ALÜMİNYUM ERGİTME KONVEYÖR SİSTEMİ

INDUCTION ALUMINIUM MELTING CONVEYOR SYSTEM



• TEKNİK ÖZELLİKLER

- Ergimiş metalin karıştırılması ve en iyi verimlilik için
- Düşük frekans, katı hal, paralel rezonans, güç dönüştürücü
- Güç dönüştürücü
- Fırın kapasitesi 10 KG - 10 TON
- İndüksiyon sistemleri ile alüminyum ergitme ve alaşımlama ocakları. Özel alüminyum alaşımları, külçeleri ve deoksidanların üretimi için

• TECHNICAL FEATURES

- For the best efficiency and mixing the molten metal
- Low frequency, Solid state, Paralel resonance, Power converters
- Converter Power 10KW -10MW
- Furnace Capacity 10 KG - 10 TON
- Aluminium melting and alloying furnaces by induction systems. For manufacturing of the special aluminium alloys, ingots and deoxidants



LABARATUVAR TİPİ İNDÜKSİYON OCAKLARI
LABORATORY TYPE INDUCTION FURNACES

GİRİŞ VOLTAJİ INPUT VOLTAGE	380/400 50 hz
GÜÇ POWER	25 KW
THERMOCUPL THERMOCOUPLE	K/S Tipi K/S Type
POTA TİPİ CRUCIBLE TYPE	A 30 Mammut Pota A 30 Mammut Crucible
ERGİTME KAPASİTESİ MELTING CAPACITY	Altın Gold (40 Kg) Bakır Copper (30 Kg) Gümüş Silver (30 Kg)



GİRİŞ VOLTAJİ INPUT VOLTAGE	380V R S T + N
GÜÇ POWER	45 KW
JENERATÖR GÜCÜ GENERATOR POWER	35 KW
THERMOCUPL THERMOCOUPLE	K/S Tipi K/S Type
POTA TİPİ CRUCIBLE TYPE	A 50 Mammut Pota A 50 Mammut Crucible
ERGİTME KAPASİTESİ MELTING CAPACITY	Altın Gold (60 Kg) Bakır Copper (50 Kg) Gümüş Silver (50 Kg)
POTA DEVİRME CRUCIBLE TILTING	Motorla ya da elle Motoriset of Manual



**İNDÜKSİYON OCAKLARI İÇİN ÖZEL POTALAR
SİC CRUCIBLE**

No.	H (mm)	D (mm)	d (mm)
A 30 Pota	290	230	160
A 50 Pota	330	270	195

MAMMUT-WETRO
Schmelztiegelwerk GmbH



LABARATUVAR TİPİ İNDÜKSİYON OCAKLARI

LABORATORY TYPE INDUCTION FURNACES

• TEKNİK ÖZELLİKLER

- Silisyum karbür pota (daha uzun ömürlü)
- Maksimum 1500 °C
- Dışardan soğutma (22 °C su sıcaklığı)
- (Bakır, Altın, Bronz, Gümüş)
- A1, A5 - 10 KW > Eritme süresi 10 dk
- A10, A15 - 15-20 KW > 15 dk
- A20, A30 - 25-30 KW > 25 dk
- A50 - 45 KW > 30 dk
- A80 - 60 KW > 45 dk
- A120 - 70 KW > 60 dk

• TECHNICAL FEATURES

- Silisyum karbür pota (daha uzun ömürlü)
- Maksimum 1500 °C
- Dışardan soğutma (22 °C su sıcaklığı)
- (Bakır, Altın, Bronz, Gümüş)
- A1, A5 - 10 KW > Eritme süresi 10 dk
- A10, A15 - 15-20 KW > 15 dk
- A20, A30 - 25-30 KW > 25 dk
- A50 - 45 KW > 30 dk
- A80 - 60 KW > 45 dk
- A120 - 70 KW > 60 dk



Laboratuvar Tipi İndüksiyon Ocakları
Laboratory Type Induction Furnaces



Lama Tavlama Ocakları
Bar Annealing Furnaces

LAMA TAVLAMA OCAKLARI

BAR ANNEALING FURNACES

• TEKNİK ÖZELLİKLER

- Madeni direkt ısıtma (potasız)
- Maksimum sıcaklık 1000 °C
- (Gümüş, Altın, Bakır, Bronz)
- Dışardan soğutuculu 22 °C su sıcaklığı
- 25x40 mm altın için ısıtma süresi maksimum 4 dk (24 ayar altın)
- 15 KW güç
- Termosta ve su akışı kontrolü
- İsteğe bağlı eklenebilir lazer ısı ölçer

• TECHNICAL FEATURES

- Madeni direkt ısıtma (potasız)
- Maksimum sıcaklık 1000 °C
- (Gümüş, Altın, Bakır, Bronz)
- Dışardan soğutuculu 22 °C su sıcaklığı
- 25x40 mm altın için ısıtma süresi maksimum 4 dk (24 ayar altın)
- 15 KW güç
- Termosta ve su akışı kontrolü
- İsteğe bağlı eklenebilir lazer ısı ölçer

TALAŞ PRESLEME MAKİNELERİ
PRESSING MACHINES

AHŞAP TALAŞI VE TOZU BRİKETLEME PRESLERİ / WOOD SCRAP AND POWDER BRIQUETTING PRESSES



METAL TALAŞI VE TOZU BRİKETLEME PRESLERİ / METAL SCRAP AND POWDER BRIQUETTING PRESSES



ÖZEL GRUP BRİKETLEME PRESLERİ / SPECIAL GROUP BRIQUETTING PRESSES



DÖKÜMHANE EKİPMANLARI FOUNDRY EQUIPMENTS

Alüminyum kapasitesi 1 Kg dan 5 Kg. kadar özel tasarım otomatik sfero kepçeler
Special design ladle bowl types with aluminium capacity from 1 kg to 5 kg. tor automatic ladles

PATENTLİ ÜRÜN
PATENTED PRODUCT



Sfero özel alaşım kepçeler
Special alloy ladles

Otomatik robot "T" kepçeler
"T" form automatic robot ladles



2 kg - 11 kg arası



250 gr - 2.1 kg arası

Otomatik robot kepçeler
Automatic robot ladles



1 kg - 8 kg arası

Seramik Kepçeler
Ceramic ladles



Külçe Kalıpları
Ingot Moulds



Kevgirler
Skimmers

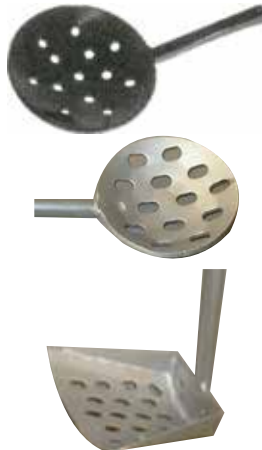

Ø18 mm 50 mm arası

Maşalar
Tongs



SİC TERMOCUPL KORUYUCU KILIFLAR

SİC THERMOCOUPLE PROTECTION SHEATS

Ürün Adı : Tüpsüz	D (mm)	d (mm)	L (mm)
Product Name : Without Tube			
RY 35	50	25	500
RY 78	50	25	600
RY 24	50	25	700
RY 75	50	25	750
RY 116	50	25	900
RY 120	50	25	1000
RY 68	50	25	1200
RY 49	60	30	500
RY 102/27	50	25	1200

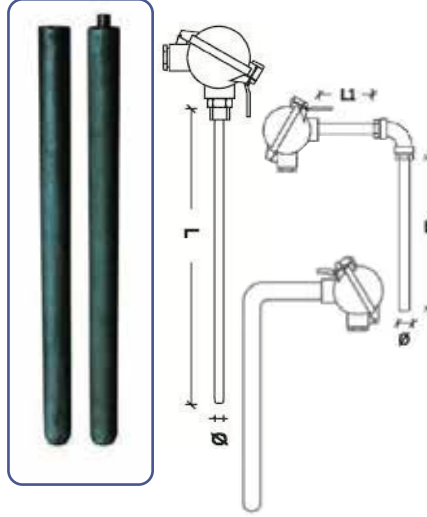

Ürün Adı : Tüpsüz	D (mm)	d (mm)	L (mm)
Product Name : Without Tube			
RY 35 E	50	25	500
RY 78 E	50	25	600
RY 24 E	50	25	700
RY 75 E	50	25	800
RY 116 E	50	25	900
RY 120 E	50	25	1000
RY 68 E	50	25	1200
RY 268 E	50	25	1300
RY 83 E	50	25	800
RY 256 E	50	25	1300
RY 75 E1	50	25	750

TERMOCUPLLAR

THERMOCOUPLES



S Tipi Termokupllar 1500-1800 °C

S Types Thermocouples 1500-1800 °C

KER 530 (Maksimum çalışma sıcaklığı 1600 °C)

KER 530 (Maximum operating temp 1600 °C)

KER 610 (Maksimum çalışma sıcaklığı 1500 °C)

KER 610 (Maximum operating temp 1500 °C)

KER 799 (Maksimum çalışma sıcaklığı 1800 °C)

KER 799 (Maximum operating temp 1800 °C)

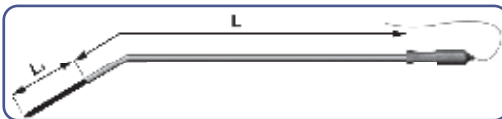

Daldırma El Probları 1XNiCrNi Tipi 1200 °C

Immersion handheld Probe 1XNiCrNi Type 1200 °C

Ø 16 mm L : 800 mm L 1 : 200 mm

Ø 16 mm L : 1200 mm L 1 : 00 mm

Ø 16 mm L : 1200 mm L 1 : 500 mm

Ø 16 mm L : 1200 mm L 1 : 760 mm



K Tipi Termokupllar 850-1050 °C

K Types Thermocouples 850-1050 °C

1.4301 DIN Paslanmaz (304 Kalite)

1.4301 DIN Stainless Steel (304 Kalite)

1.4541 DIN Paslanmaz (321 Kalite)

1.4541 DIN Stainless Steel (321 quality)

1.4749 DIN Paslanmaz (446 Kalite)

1.4841 DIN Paslanmaz (314 quality)

2.4816 DIN Paslanmaz (314 Kalite)

2.4816 DIN Paslanmaz (INCONEL-600)

Infrared Tabancalar
0/+1050 °C
Infrared Thermometer
0/+1050 °C



50 °C - 2200 °C

Dijital El Termometresi
K Tipi -5/+1200 °C
Digital Handheld Thermometer
K Type -5/+1200 °C



TERMOCUPLLAR

THERMOCOUPLES



*Isı Kaydedici



*Termocupl Kabloları



TERMOCUPLLAR

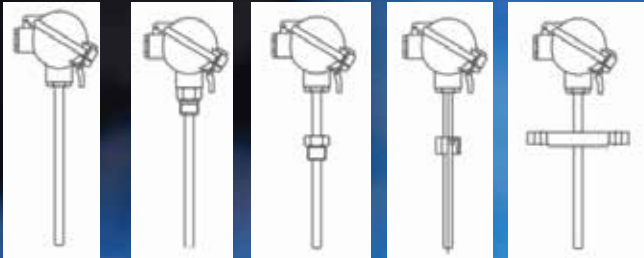

THERMOCOUPLES

SİLİKON NİTRİT TERMOCUPL BAĞLANTI ADAPTÖRLERİ

SILICONE NITRITE THERMOCOUPLE CLAMPING FIXTURES

Sabit Başlı Adaptör	
Dış Çap (mm)	İç Çap (mm)
28	16
22	12
16	08
16	09
10	05

Oynar Başlı Adaptör	
Dış Çap (mm)	İç Çap (mm)
28	16
22	12
16	08
16	09
10	05



Sabit ya da Oynar Başlı

➤ Bağlantı adaptörü sayesinde küçük darbeleri absorbe edebilme özelliği

It can absorb the small impacts thanks to the connection adaptor.



- Minimum 12 ayla 24 ay arası uzun ömür,
Lifetime between minimum 12 months and 24 months.
- Yüksek mukavemet ve mekanik direnç,
High resistance and mechanical strength.
- Yüksek termal iletkenlik sonucu çok hızlı ve doğru ölçüm
As a result of high thermal conductivity, very quick and accurate measurement.
- Alüminyum yapışmaz, korozyon ve cüruf oluşturmaz
Aluminium does not stick, no corrosion and no dross happen.
- Yapışan alüminyum çok çabuk ve kolay temizlenir,
Aluminium skin can be removed very quickly and easily.



REFRAKTER MALZEMELER
REFRACTORY MATERIALS
SERAMİK ELYAF İZOLASYON ÜRÜNLERİ / CERAMIC FIBER ISOLATION PRODUCTS
SERAMİK ELYAF BATTANİYELER
CERAMIC FIBER BLANKETS

Ebatlar Size	Yoğunluk Density	Sıcaklık Temperature
28800 x 610 x 6 mm	96 - 128 g/cm ³	1260 ve 1430 °C
14400 x 610 x 13 mm		
7200 x 610 x 25 mm		
3600 x 610 x 50 mm		

SERAMİK ELYAF PLAKALAR
CERAMIC FIBER BOARDS

Ebatlar Size	Yoğunluk Density	Sıcaklık Temperature
1200 x 1000 x 10 mm	280 - 300 g/cm ³	1260 ve 1400 °C
1200 x 1000 x 15 mm		
1200 x 1000 x 20 mm		
1200 x 1000 x 25 mm		
1200 x 1000 x 50 mm		

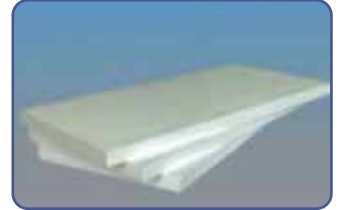
SERAMİK ELYAF KAĞITLAR
CERAMIC FIBER PAPERS

Ebatlar Size	Yoğunluk Density	Sıcaklık Temperature
40000 x 1000 x 1 mm	200 +/- 15 g/cm ³	1260 °C
30000 x 1000 x 2 mm		
20000 x 1000 x 3 mm		
10000 x 1000 x 5 mm		
10000 x 1000 x 6 mm		

SERAMİK ELYAF TEKSTİL ÜRÜNLERİ / CERAMIC FIBER TEXTILE PRODUCTS

REFRAKTER MALZEMELER

REFRACTORY MATERIALS

AVRUPA REZİSTANS TELLERİ / EUROPEAN RESISTANCE WIRES



AVRUPA SERAMİK BORULAR / EUROPEAN CERAMIC TUBES



ELYAF MODÜLLER / FIBER MODULS



KAYA YÜNÜ PLAKALAR / ROCKWOOL BOARDS

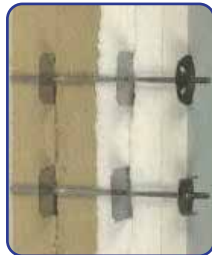

REFERANSLARIMIZ

OUR REFERENCES



DOĞUŞ MACHINE





REFERANSLARIMIZ

OUR REFERENCES



DOĞUŞ MACHINE





İLETİŞİM BİLGİLERİMİZ

CONTACT INFORMATION



Factory Center: Tepeören İTOSB Mah. 9. Cad. No: 6 Tuzla / İstanbul

Tel: +90 216 444 28 81 | **Fax:** +90 216 504 60 94 | www.dogusmetal.com

Europe Office: Rami Kışla Cad. Topçular İş Merkezi No: 236/248 34055 Eyüp / İstanbul - Türkiye

Tel: +90 212 565 71 18 | **Fax:** +90 212 565 71 18 - 567 13 37



www.dogusmetal.com



Uzman Kadro
Expert Staff



Teknik Servis
Technical Service



+90 444 28 81

ÇAĞRI MERKEZİ
CALL CENTER



Danışmanlık Hizmetleri
Consulting Services



Şehir İçinde Adrese
Teslimat
Local Transport to
Address



KIRIKKALE ÜNİVERSİTESİ
TEKNO PARK





Fabrika Merkez (Factory)

İ.T.O.S.B 9.Cad No:6 34959 Tuzla / İstanbul

Tel (Ph): +90 444 2 881 Fax: +90 216 504 60 94

Avrupa Ofis Şube ve Depo (Branch)

Rami Kışla Cad. Topçular İş Merkezi No: 70/236-248 Eyüp / İstanbul

Tel (Ph): +90 212 565 71 18 Fax: +90 212 567 13 37

[f](#) [in](#) [t](#) [@](#) [v](#) /dogusdokum | www.dogusmetal.com



TEKNO PARK

